



2025 PRODUCT CATALOG

THIS PAGE IS INTENTIONALLY LEFT BLANK

Table of Contents

About API International.....	01.1
Overview and Services.....	01.2
Terms & Conditions of Sale.....	01.3
Flange Dimensional Tolerances.....	01.4
AWWA Flanges (C207/C228 Specifications).....	02.01
Class “B” Steel Ring Flanges (Series PF-B).....	02.02
Class “D” Steel Ring Flanges (Series PF-D).....	02.03-04
Class “D” Steel Overbore Ring Flanges (Series PFOB-D).....	02.05
Class “E” Steel Ring Flanges (Series PF-E).....	02.06
Class “E” Steel Overbore Ring Flanges (Series PFOB-E).....	02.07
Class “F” Steel Ring Flanges (Series PF-F).....	02.08
Class “B” Steel Blind Flanges (Series PFBL-B).....	02.09
Class “D” Steel Blind Flanges (Series PFBL-D).....	02.10
Class “E” Steel Blind Flanges (Series PFBL-E).....	02.11
Class “F” Steel Blind Flanges (Series PFBL-F).....	02.12
Class “D” Steel Hub Ring Flanges (Series PF-D-H).....	02.13
Class “E” Steel Hub Ring Flanges (Series PF-E-H).....	02.14
Class “SA” Stainless Steel Ring Flanges (Series SPF-A).....	02.15
Class “SB” Stainless Steel Ring Flanges (Series SPF-B).....	02.16
Class “SD” Stainless Steel Ring Flanges (Series SPF-D).....	02.17
Class “SE” Stainless Steel Ring Flanges (Series SPF-E).....	02.18
Class “SF” Stainless Steel Ring Flanges (Series SPF-F).....	02.19
Class “SA” Stainless Steel Blind Flanges (Series SPFBL-A).....	02.20
Class “SB” Stainless Steel Blind Flanges (Series SPFBL-B).....	02.21
Class “SD” Stainless Steel Blind Flanges 1986 (Series SPFBL-86).....	02.22
Class “SD” Stainless Steel Blind Flanges (Series SPFBL-D).....	02.23
Class “SE” Stainless Steel Blind Flanges (Series SPFBL-E).....	02.24
Class “SF” Stainless Steel Blind Flanges (Series SPFBL-F).....	02.25
Light Weight Flanges (½" & ⅝" Thick).....	03.1
½" Thick Steel Slip-on Flanges (Series PFH).....	03.2
½" Thick Thick Reducing Steel Flanges (Series PFHR).....	03.3
½" Thick Steel Slip-on Flanges for O.D. Tubing (Series PFH-16).....	03.4
½" Thick Steel Blind Flanges (Series PFBH).....	03.4
½" Thick Stainless Steel Flanges for Pipe (Series SPFH).....	03.5
½" Thick Stainless Steel Flanges for O.D tubing (Series SPFH-16).....	03.5
½" Thick Reducing Stainless Steel Flanges (Series SPFHR).....	03.6
½" Thick Stainless Steel Blind Flanges (Series SPFBH).....	03.7
⅝" Thick Steel Slip-on Flanges (Series PF-063).....	03.8
Miscellaneous Plate Flanges.....	04.1
Class 150 Steel Plate Flanges (Series PF).....	04.2
Class 150 Stainless Steel Plate Flanges (Series SPF).....	04.3
Butterfly Valve Adapter Flanges (Series 4020).....	04.4
ANSI/ASME B16.5 Forged Flanges Raised Face Flanges.....	05.01
Class 150 Forged Steel Flat Face Slip-on Flanges (Series FFS).....	05.02
Class 150 Forged Steel Raised Face Slip-on Flanges (Series RFS).....	05.03
Class 150 Forged Steel Raised Face Blind Flanges (Series RFB).....	05.04
Class 300 Forged Steel Raised Face Slip-on Flanges (Series RFS-30).....	05.05
Class 300 Forged Steel Raised Face Blind Flanges (Series RFB-30).....	05.06
Class 150 Forged Stainless Steel Raised Face Slip-on Flanges (Series SRFS).....	05.07
Class 150 Forged Stainless Steel Raised Face Blind Flanges (Series SRFB).....	05.08
Class 300 Forged Stainless Steel Raised Face Slip-on Flanges (Series SRFS-30).....	05.09
Class 300 Forged Stainless Steel Raised Face Blind Flanges (Series SRFB-30).....	05.10

Table of Contents - Continued

Exhaust Flanges.....	06.1
Round Exhaust Steel Flanges (Series PFE).....	06.2
½" Thick Reducing Steel Flanges (Series PFHR).....	06.3
½" Thick Reducing Stainless Steel Flanges (Series SPFHR).....	06.4
Square Exhaust Steel Flanges (Series PFES).....	06.5
DIN (Metric) Flanges.....	07.1
Quick reference chart.....	07.2
DIN-PN10 Steel Slip-on Flanges (Series DIN-P10).....	07.3
DIN-PN10 Steel Slip-on Flanges (EN 1092-1:2007 Spec's).....	07.3
DIN-PN16 Steel Slip-on Flanges (EN 1092-1:2007 Spec's).....	07.4
DIN-PN25 Steel Slip-on Flanges (EN 1092-1:2007 Spec's).....	07.5
DIN-PN10 Stainless Steel Slip-on Flanges (Series SDIN-P10).....	07.6
DIN-PN16 Stainless Steel Slip-on Flanges (Series SDIN-P16).....	07.7
Backing Flanges & Stub Ends.....	08.1
Ductile Iron Backing Flanges for Angle Face Rings (Series ABF).....	08.2
Stainless Steel Backing Flanges for Angle Face Rings (Series SABF).....	08.3
Ductile Iron Backing Flanges for Stub Ends (Series BF).....	08.4
Stub Ends (Series SE).....	08.5
Valves & Accessories.....	09.1
Wafer Style Butterfly Valves (Series BV).....	09.2-3
Valve Extensions for Butterfly Valves (Series VE).....	09.4
Double-Door Check Valves (Series CV).....	09.5
Rubber Expansion Joints & Accessories.....	10.1
Flanged Molded Rubber Expansion Joints (Series AMS, SAMS, AMT & SAMT).....	10.2-4
Flanged Molded Rubber Expansion Joints (Series AJS, SAJS, AJT & SAJT).....	10.5-7
Threaded Union Molded Rubber Expansion Joints (Series AMU).....	10.8
Control Rod Units (Series CRU).....	10.9
Split Retaining Rings (Class 150) - Zinc Plated Steel & Stainless Steel (Series RR & SRR).....	10.10
Split Retaining Rings (Class 300) - Zinc Plated Steel (Series RR-30).....	10.11
Pump Connectors.....	11.1
Stainless Steel Braided - Flange x Flange (Series PCF).....	11.2
Stainless Steel Braided - Male x Male (Series PCT).....	11.2
Fittings & Accessories.....	12.1
Threaded Half Couplings (Series THC).....	12.2
Threaded Both End Nipples (Series TOE).....	12.3
Threaded Both End Nipples (Series TBE).....	12.4
304L Stainless Steel 90 Degree Long Radius Elbow (Series LRE).....	12.5
Gaskets (Series GNA & GRR).....	12.6-7
Hydraulic Motor Pump Brackets (Series HB).....	12.8
Exhaust Rain Caps (Series RC).....	12.9

Table of Contents - Continued

KLAMPz Grooved Piping System (UL/FM)	13.01
All Parts Overview.....	13.02
Pipe Size Reference Sheet.....	13.03
K05 Light Weight Flexible Coupling.....	13.04
K10 & K11 Elbows.....	13.05
K20 Tee.....	13.06
K41 Flange Adapter.....	13.07
K42 Flange Adapter.....	13.08
K58 Adapter Nipples.....	13.09
K60 Grooved Cap.....	13.10
Gaskets (EPDM).....	13.11
Nuts & Bolts.....	13.12
KLAMPz Warranty.....	13.13
Machining Services - Features & Capabilities	14.1
Machining Services Information.....	14.2
Butterfly Valves Installation, Operation, & Maintenance Guide	15.1
General Information.....	15.2
Installation.....	15.3-4
Maintenance.....	15.5
Rubber Expansion Joints Installation Guide	16.1
Preparation.....	16.2
Installation.....	16.3

This product catalog is for informational purposes only. API International makes no warranties, expressed or implied in this summary. Information in this catalog, including but not limited to: pricing, dimensions, and pressures, is subject to change without notice.

© Copyright 2020 API International, Inc. Printed in the United States.

THIS PAGE IS INTENTIONALLY LEFT BLANK



Your source for flanges, pipe fittings, and custom solutions!

API International is a manufacturer and wholesale distributor of flanges, expansion joints, valves, other pipe fittings and custom fabricated parts for the Agriculture, Exhaust, HVAC and Water Works industries. We stock parts in our conveniently located warehouses for quick distribution throughout the United States, and our Machine Shop can modify stock items or produce custom product to meet your unique specifications.



API Headquarters - Office Building

We strive to be the easiest company to work with. That is why we are quick to respond, keep the right products in inventory and take full ownership over every order that comes to us. We maintain a large sales staff so that when you call there is always an actual person there to answer. From making sure we meet requirements to getting your order shipped out on time, we hold ourselves accountable.



Services

International Procurement



During our forty-plus years of doing business internationally we have developed alliances with suppliers in Asia and Europe. Our overseas representatives maintain a close partnership with our current suppliers and are continuously engaged in source finding on our client's behalf.

Our international representatives reside in the area that they service. Because of this, they are experts in local tradition, dialects, and acceptable business practices applicable to each region. When you elect to work with **API International** for your procurement needs, you have instant access to our knowledge base of how to successfully conduct business in the markets that we buy from.

Custom Fabrication



One of **API International's** core competencies is fabricating custom parts in a variety of alloys for our OEM customers. Our team of professionals work with our engineering department and select manufacturers to customize high quality products for your unique requirements.

Logistics Services



API's logistics services are designed to allow OEMs to focus on the manufacturing process without worrying about when their custom parts will be available for use. Our range of services includes all logistical aspects for OEM customers: shipping from our network of overseas manufacturers; freight forwarding; customs clearing; local trucking; material handling and warehousing in one of our

facilities. We handle all of the pieces of the logistics puzzle, enabling our OEMs clients to maintain inventory levels of quality controlled products that match their production timeline.

We give our customers the option of either utilizing our warehouse space to inventory blanket orders or shipping containers directly to a manufacturing facility. In addition, when customers elect to utilize your own warehouse, we are happy to customize box dimensions to match our customer's warehouse rack dimensions.

Standard Terms and Conditions of Sale

UNLESS OTHERWISE AGREED TO IN WRITING, THE FOLLOWING PROVISIONS APPLY TO ALL SALES:

1) SALES:

All merchandise ordered shall be sold subject to SELLER'S standard warranty, viz: SELLER warrants that any product of its manufacture, which upon examination is found by SELLER'S representative to be defective either in the workmanship of material whereby it is not suitable under proper usage and service for the purpose for which it was designed, will be at SELLER'S option, repaired or replaced free of charge including transportation charges, but not the cost of installation, provided that SELLER received written claim specifying the defect within 1-year from the date of shipment to the original purchaser. Warranty excludes sales of gasket products. ALL OTHER WARRANTIES EXPRESSED AND IMPLIED INCLUDING ANY WARRANTY OF MERCHANTABILITY ARE HEREBY DISCLAIMED. The foregoing expresses all of the SELLER'S obligations and liabilities with respect to the quality of items furnished by it and it shall under no circumstances be liable for consequential damages.

2) MINIMUM ORDER REQUIREMENT: All orders must meet a minimum purchase amount of \$150.00. Any machine shop services must meet a minimum \$100.00 material *and* \$150.00 machining charge.

3) ORDER ACCEPTANCE BY SELLER:

- All orders received from BUYER are subject to acceptance by SELLER, unless the quotation specifies that it is a bid in response to an invitation for bids, in which event the order or award shall constitute acceptance of the bid in accordance to bid terms.
- Terms and conditions on the BUYER'S order form, at variance with terms and conditions stated herein, are binding upon SELLER only if specifically accepted by SELLER in writing.
- Orders accepted by SELLER cannot be canceled by BUYER except with SELLER'S written consent and upon terms that will indemnify SELLER against loss.
- Initial order for new customers (pending finance approval) must meet a \$500.00 product minimum (freight excluded).

4) SAMPLES: In the event samples are furnished to BUYER, SELLER will not assume any liability in connection with the furnishing of use thereof, and there will be no agreement of warranty collateral to, or affecting, the furnishing of such samples.

5) PRICE AND PAYMENT:

- All goods are sold at the prices stated in the offer. All offers are subject to approval, acceptance, and correction by API International, Inc. Any offers containing errors in quotations will be corrected by API International and resubmitted to BUYER for acceptance or refusal. All prices are subject to change without notice.
- Unless otherwise stated, legal delivery and prices are F.O.B. SELLER'S plant, and prices do not include transportation charges.
- Taxes Not Included In Price: Except where otherwise prohibited by law, all sales, excise, use, or similar taxes or charges by the federal, any foreign, or any state or local government, which SELLER may be required to pay or collect, shall be in addition to the price stated and shall be paid by BUYER, unless valid exception certificate is furnished therefore.
- Payment: All accounts are payable on or before the date due listed on the invoice, which is based on the terms of the account. SELLER may demand payment in advance of shipment if, in SELLER'S opinion, the credit or financial condition of BUYER is, or is about to become, impaired.
- Payments Where Shipments are Delayed: Where BUYER requests a delay in shipment, SELLER shall have the option of billing for goods when ready for shipment. If material is not ordered out within sixty (60) days after goods are ready, SELLER will have the option of billing storage charges.

6) DELIVERY:

- Shipping Dates: Shipping dates are approximate only and subject to change.
- Unforeseen Delays: SELLER shall not be liable in damages or otherwise for delays or failure in performance when caused by circumstance of every nature and description and, however arising, beyond SELLER'S reasonable control in the event SELLER is unable due to any such occurrence or otherwise, to fulfill its total commitment to all customers, BUYER agrees to accept as full and complete performance by SELLER, deliveries in accordance with such plan or pro-rata as SELLER may adopt.
- Packaging: SELLER will provide commercial packaging adequate, under normal conditions, to protect the goods in shipment and identify the contents. Should BUYER request any special packaging, it will be done at BUYER'S expense.
- Routing: All goods will be shipped via the least expensive or most expeditious means of transportation under the circumstances unless BUYER indicates otherwise. If BUYER provides no routing instructions, SELLER shall be the sole judge of the best method of routing shipment.
- All claims for damages or shortages must be made to API International within 48 hours of receipt of shipment. Damages in shipment shall remain the responsibility of BUYER, unless otherwise provided in writing by SELLER.

7) INSPECTION: SELLER will inspect all goods prior to shipment, and such inspection will be adequate to meet SELLER'S standards for dimensional and visual characteristics.

8) REJECTION: Any claim for non-conformance of products with the order must be made in writing within thirty (30) days of receipt of shipment, or BUYER hereby waives any such objection. In the event such claim is filed, SELLER shall have a reasonable time to investigate the circumstances and repair or replace any such products as found to be non-conforming.

9) RETURNS:

- No goods may be returned by BUYER for any reason without SELLER'S prior written approval.
- All returns must be pre-approved and accompanied by an RMA (Return Material Authorization) issued by API International. All returns must be shipped freight prepaid unless otherwise specified on the RMA.
- Special, custom fabricated, or modified items will not be accepted for return.
- Items not listed in the current API International catalog or items purchased more than 90 (ninety) days prior to the requested return date will not be accepted.
- Current catalog items will be subjected to a minimum 25% restocking charge.
- All items will be inspected upon receipt and must be in good, re-saleable condition. Parts returned that are not in saleable condition will be either subject to an additional rework charge or possibly no credit will be issued.
- Once credit amount is determined, the refund will be posted to the BUYER'S account. Cash refunds will not be issued.

10) SPECIAL DAMAGES: Neither BUYER NOR SELLER shall make any claims for special consequential damages.

11) PATENT INFRINGEMENT: Should the goods furnished by SELLER be of such a nature that the design, therefore, is supplied by BUYER, or should the goods be labeled or marked with a trademark or trade name requested by BUYER, then BUYER agrees to defend SELLER in any action, either civil or criminal, brought against SELLER by any third party, for the infringement or misuse of any such patents or trademarks, and BUYER further agrees to hold SELLER harmless from any damage or loss resulting therefrom.

12) GENERAL PROVISIONS:

- Modifications of Contract: It is agreed that there is no other contract in force between BUYER and SELLER and no alteration shall be binding unless agreed to in writing by SELLER. Should SELLER by any words, acts, or writing, waive or be deemed to have waived any of the provisions of this agreement, or should SELLER fail to insist upon performance by BUYER of one or more of the terms herein, such action or failure on SELLER'S part will in no way be deemed to imply or constitute a waiver of any other terms contained in this agreement.
- Compliance with Laws: SELLER certifies compliance with all relevant Federal, State, and local laws, including Paragraph 6, 7, and 12 of the Fair Labor Standards Act as amended and any regulations and orders issued under Paragraph 14 thereof.
- In the event of a suit or action over the terms of this sale, the prevailing party shall be entitled to recover from the other party such sum as the court may judge reasonable, as attorney fees at trial or on appeal venue.
- Any suit or action brought as a result of any sale covered by these conditions shall be brought in the state of Oregon, and the laws of the State of Oregon shall apply.
- API International reserves the right, in its sole discretion, to change the Terms under which www.apiint.com is offered. The most current version of the Terms will supersede all previous versions. API International encourages you to periodically review the Terms to stay informed of our updates.

Flange Dimensional Tolerances

OUTSIDE DIAMETER	For O.D. \leq 24.00"	+0.125", -0.062"
	For O.D. $>$ 24.00"	+0.125", -0.125"
INSIDE DIAMETER	For I.D. \leq 10.00"	+0.031", -0.000"
	For I.D. $>$ 10.00"	+0.062", -0.000"
CONTACT FACE DIAMETER	Raised Face	+0.015", -0.015"
DRILLING	Bolt Hole Diameter	+0.031", -0.031"
	Bolt Circle Diameter	+0.062", -0.062"
	Bolt Hole Spacing	+0.031", -0.031"
THICKNESS	For Nominal Size \leq 18"	+0.125", -0.000"
	For Nominal Size \geq 20"	+0.187", -0.000"

AWWA Flanges

C207/C228 Specifications

Domestic & Import

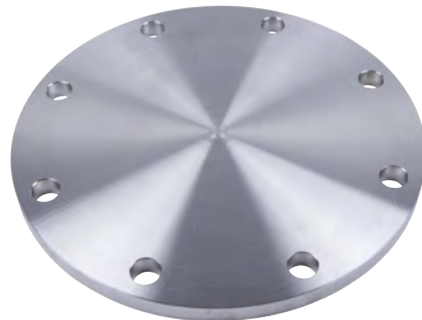

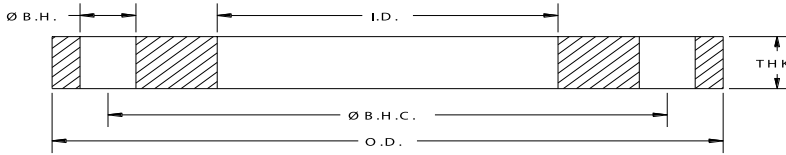

AWWA Class “B” C207 Steel-Ring Flanges [86 psi]

API Part Number	Size	O.D.	I.D.	Ø B.H.C.	Ø B.H.	# B.H.	THK	Weight Lbs
PF0400-B	4	9.00	4.57	7.50	0.750	8	0.625	7.7
PF0500-B	5	10.00	5.66	8.50	0.875	8	0.625	8.6
PF0600-B	6	11.00	6.72	9.50	0.875	8	0.688	10.7
PF0800-B	8	13.50	8.72	11.75	0.875	8	0.688	15.3
PF1000-B	10	16.00	10.88	14.25	1.000	12	0.688	19.2
PF1200-B	12	19.00	12.88	17.00	1.000	12	0.688	28.1
PF1400-B	14	21.00	14.19	18.75	1.125	12	0.688	34.4
PF1600-B	16	23.50	16.19	21.25	1.125	16	0.688	41.3
PF1800-B	18	25.00	18.19	22.75	1.250	16	0.688	41.2
PF2000-B	20	27.50	20.19	25.00	1.250	20	0.688	48.6
PF2200-B	22	29.50	22.19	27.25	1.375	20	0.750	56.8
PF2400-B	24	32.00	24.19	29.50	1.375	20	0.750	67.0
PF2600-B	26	34.25	26.19	31.75	1.375	24	0.812	79.3
PF2800-B	28	36.50	28.19	34.00	1.375	28	0.875	93.7
PF3000-B	30	38.75	30.19	36.00	1.375	28	0.875	103.9
PF3200-B	32	41.75	32.19	38.50	1.625	28	0.938	131.3
PF3400-B	34	43.75	34.19	40.50	1.625	32	0.938	137.0
PF3600-B	36	46.00	36.19	42.75	1.625	32	1.000	159.7
PF3800-B	38	48.75	38.19	45.25	1.625	32	1.000	184.5
PF4000-B	40	50.75	40.19	47.25	1.625	36	1.000	191.5
PF4200-B	42	53.00	42.19	49.50	1.625	36	1.125	232.5
PF4400-B	44	55.25	44.19	51.75	1.625	40	1.125	247.6
PF4600-B	46	57.25	46.19	53.75	1.625	40	1.125	258.6
PF4800-B	48	59.50	48.19	56.00	1.625	44	1.250	304.9
PF5000-B	50	61.75	50.19	58.25	1.875	44	1.250	315.2
PF5200-B	52	64.00	52.19	60.50	1.875	44	1.250	336.9
PF5400-B	54	66.25	54.19	62.75	1.875	44	1.375	395.1
PF6000-B	60	73.00	60.19	69.25	1.875	52	1.500	506.1
PF6600-B	66	80.00	66.19	76.00	1.875	52	1.625	661.1
PF7200-B	72	86.50	72.19	82.50	1.875	60	1.750	798.8
PF7800-B	78	93.00	78.19	89.00	2.125	64	2.000	995.6
PF8400-B	84	99.75	84.19	95.50	2.125	64	2.000	1140.7
PF9000-B	90	106.50	90.19	102.00	2.438	68	2.250	1408.8
PF9600-B	96	113.25	96.19	108.50	2.438	68	2.250	1591.2
PF10200-B	102	120.00	102.19	114.50	2.688	72	2.500	1918.7
PF10800-B	108	126.75	108.19	120.75	2.688	72	2.500	2142.6
PF11400-B	114	133.50	114.19	126.75	2.938	76	2.750	2534.1
PF12000-B	120	140.25	120.19	132.75	2.938	76	2.750	2803.9
PF12600-B	126	147.00	126.19	139.25	3.188	80	3.000	3263.6
PF13200-B	132	153.75	132.19	145.75	3.188	80	3.000	3583.5
PF14400-B	144	167.25	144.19	158.25	3.438	84	3.250	4489.5

Notes:

- a. Steel material conforms to the requirements of AWWA C207 specifications. Other material is available upon request.
- b. Meets ANSI class 150 pattern.
- c. For flanges in smaller sizes see page 4.2.

Pressure Ratings: 86psi at atmospheric temperature.

ALL DIMENSIONS ARE IN INCHES UNLESS OTHERWISE STATED.

DC# 0524

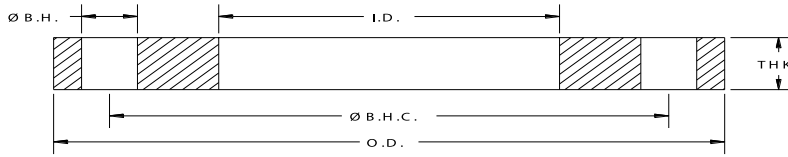

AWWA Class “D” C207 Steel-Ring Flanges [150-175 psi]

API Part Number	Size	O.D.	I.D.	Ø B.H.C.	Ø B.H.	# B.H.	THK	Weight Lbs
PF0400-D	4	9.00	4.57	7.50	0.750	8	0.625	7.7
PF0500-D	5	10.00	5.66	8.50	0.875	8	0.625	8.6
PF0600-D	6	11.00	6.72	9.50	0.875	8	0.688	10.7
PF0800-D	8	13.50	8.72	11.75	0.875	8	0.688	15.3
PF1000-D	10	16.00	10.88	14.25	1.000	12	0.688	19.2
PF1200-D	12	19.00	12.88	17.00	1.000	12	0.812	33.1
PF1400-D	14	21.00	14.19	18.75	1.125	12	0.938	46.8
PF1600-D	16	23.50	16.19	21.25	1.125	16	1.000	60.1
PF1800-D	18	25.00	18.19	22.75	1.250	16	1.062	63.7
PF2000-D	20	27.50	20.19	25.00	1.250	20	1.125	79.5
PF2200-D	22	29.50	22.19	27.25	1.375	20	1.188	89.9
PF2400-D	24	32.00	24.19	29.50	1.375	20	1.250	111.6
PF2600-D	26	34.25	26.19	31.75	1.375	24	1.312	128.1
PF2800-D	28	36.50	28.19	34.00	1.375	28	1.312	140.6
PF3000-D	30	38.75	30.19	36.00	1.375	28	1.375	163.3
PF3200-D	32	41.75	32.19	38.50	1.625	28	1.500	210.0
PF3400-D	34	43.75	34.19	40.50	1.625	32	1.500	219.1
PF3600-D	36	46.00	36.19	42.75	1.625	32	1.625	259.4
PF3800-D	38	48.75	38.19	45.25	1.625	32	1.625	299.8
PF4000-D	40	50.75	40.19	47.25	1.625	36	1.625	311.1
PF4200-D	42	53.00	42.19	49.50	1.625	36	1.750	361.7
PF4400-D	44	55.25	44.19	51.75	1.625	40	1.750	385.1
PF4600-D	46	57.25	46.19	53.75	1.625	40	1.750	402.2
PF4800-D	48	59.50	48.19	56.00	1.625	44	1.875	457.3
PF5000-D	50	61.75	50.19	58.25	1.875	44	2.000	504.4
PF5200-D	52	64.00	52.19	60.50	1.875	44	2.000	539.1
PF5400-D	54	66.25	54.19	62.75	1.875	44	2.125	610.6
PF6000-D	60	73.00	60.19	69.25	1.875	52	2.250	759.1
PF6600-D	66	80.00	66.19	76.00	1.875	52	2.500	1017.0
PF7200-D	72	86.50	72.19	82.50	1.875	60	2.625	1198.2
PF7800-D	78	93.00	78.19	89.00	2.125	64	2.750	1368.9
PF8400-D	84	99.75	84.19	95.50	2.125	64	2.875	1639.7
PF9000-D	90	106.50	90.19	102.00	2.438	68	3.000	1878.2
PF9600-D	96	113.25	96.19	108.50	2.438	68	3.250	2298.4
PF10200-D	102	120.00	102.19	114.50	2.688	72	3.250	2494.3
PF10800-D	108	126.75	108.19	120.75	2.688	72	3.375	2892.5
PF11400-D	114	133.50	114.19	126.75	2.938	76	3.500	3225.2
PF12000-D	120	140.25	120.19	132.75	2.938	76	3.500	3568.6
PF12600-D	126	147.00	126.19	139.25	3.188	80	3.750	4079.5
PF13200-D	132	153.75	132.19	145.75	3.188	80	3.875	4628.6
PF14400-D	144	167.25	144.19	158.25	3.438	84	4.125	5698.3

Notes:

- a. Steel material conforms to the requirements of AWWA C207 specifications. Other material is available upon request.
- b. Meets ANSI class 150 pattern
- c. For flanges in smaller sizes see page 4.2.

Pressure Ratings: 175psi (4" - 12") and 150psi (14" and larger) at atmospheric temperature.

ALL DIMENSIONS ARE IN INCHES UNLESS OTHERWISE STATED.

DC# 0524

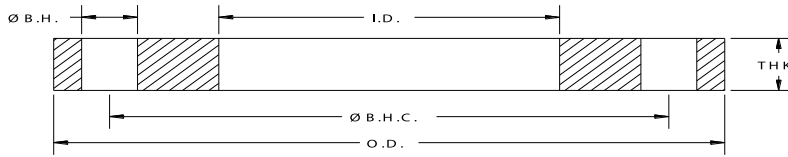

AWWA Class “D” C207 Steel-Ring Flanges for O.D. Tubing [150-175 psi]

API Part Number	Size	O.D.	I.D.	Ø B.H.C.	Ø B.H.	# B.H.	THK	Weight Lbs
PF0400-D-16	4	9.00	4.06	7.50	0.750	8	0.625	8.5
PF0500-D-16	5	10.00	5.06	8.50	0.875	8	0.625	9.6
PF0600-D-16	6	11.00	6.09	9.50	0.875	8	0.688	12.0
PF0800-D-16	8	13.50	8.09	11.75	0.875	8	0.688	17.1
PF1000-D-16	10	16.00	10.12	14.25	1.000	12	0.688	22.0
PF1200-D-16	12	19.00	12.12	17.00	1.000	12	0.812	37.9

Notes:

- a. Steel material conforms to the requirements of AWWA C207 specifications. Other material is available upon request.
- b. Meets ANSI class 150 pattern.

Pressure Ratings: 175psi (4" - 12") 150psi (14" and larger) at atmospheric temperature. ALL DIMENSIONS ARE IN INCHES UNLESS OTHERWISE STATED.

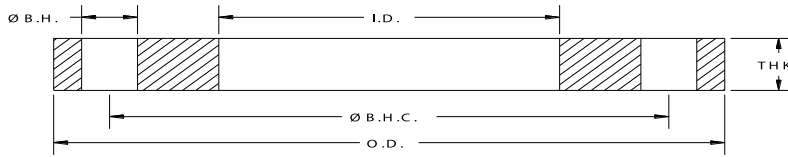

AWWA Class “D” C207 Steel-Ring Overbore Flanges [150-175 psi]

API Part Number	Size	O.D.	I.D.	Ø B.H.C.	Ø B.H.	# B.H.	THK	Weight Lbs
PFOB1400-1613-D	14	21.00	16.13	18.75	1.125	12	0.935	34.0
PFOB1600-1813-D	16	23.50	18.13	21.25	1.130	16	1.000	55.0
PFOB1800-1988-D	18	25.00	19.88	22.75	1.250	16	1.060	53.0
PFOB1800-2013-D	18	25.00	20.13	22.75	1.250	16	1.060	53.0
PFOB2000-2188-D	20	27.50	21.88	25.00	1.250	20	1.130	75.0
PFOB2400-2588-D	24	32.00	25.88	29.50	1.375	20	1.250	91.0
PFOB2400-2613-D	24	32.00	26.13	29.50	1.375	20	1.250	84.5
PFOB3000-3200-D	30	38.75	32.00	36.00	1.380	28	1.380	130.5
PFOB3600-3800-D	36	46.00	38.00	42.75	1.630	32	1.630	213.5
PFOB4200-4400-D	42	53.00	44.00	49.50	1.630	36	1.750	304.0
PFOB4800-5000-D	48	59.50	50.00	56.00	1.630	44	1.880	457.0

Notes:

- a. Steel material conforms to the requirements of AWWA C207 specifications. Other material is available upon request.
- b. Meets ANSI/ASME B16.5 Class 150 drilling pattern.
- c. Pressure Ratings: Class D. Sizes 4”-12” in, 175 psi; sizes 14” and larger, 150 psi. at atmospheric temperature.

ALL DIMENSIONS ARE IN INCHES UNLESS OTHERWISE STATED.

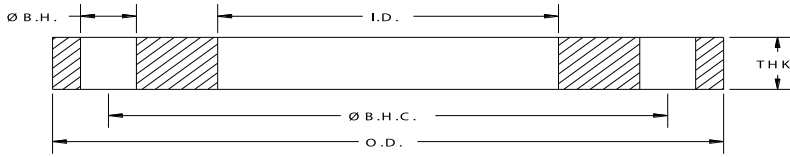

AWWA Class “E” C207 Steel-Ring Flanges [275psi]

API Part Number	Size	O.D.	I.D.	Ø B.H.C.	Ø B.H.	# B.H.	THK	Weight Lbs
PF0400-E	4	9.00	4.57	7.50	0.750	8	1.125	13.9
PF0500-E	5	10.00	5.66	8.50	0.875	8	1.188	16.3
PF0600-E	6	11.00	6.72	9.50	0.875	8	1.313	20.4
PF0800-E	8	13.50	8.72	11.75	0.875	8	1.500	33.4
PF1000-E	10	16.00	10.88	14.25	1.000	12	1.563	43.7
PF1200-E	12	19.00	12.88	17.00	1.000	12	1.750	71.4
PF1400-E	14	21.00	14.19	18.75	1.125	12	1.875	93.7
PF1600-E	16	23.50	16.19	21.25	1.125	16	2.000	120.2
PF1800-E	18	25.00	18.19	22.75	1.250	16	2.125	127.3
PF2000-E	20	27.50	20.19	25.00	1.250	20	2.375	167.8
PF2200-E	22	29.50	22.19	27.25	1.375	20	2.500	189.2
PF2400-E	24	32.00	24.19	29.50	1.375	20	2.625	234.3
PF2600-E	26	34.25	26.19	31.75	1.375	24	2.750	268.4
PF2800-E	28	36.50	28.19	34.00	1.375	28	2.750	294.5
PF3000-E	30	38.75	30.19	36.00	1.375	28	2.875	341.4
PF3200-E	32	41.75	32.19	38.50	1.625	28	3.000	420.0
PF3400-E	34	43.75	34.19	40.50	1.625	32	3.000	438.3
PF3600-E	36	46.00	36.19	42.75	1.625	32	3.125	498.9
PF3800-E	38	48.75	38.19	45.25	1.625	32	3.125	576.5
PF4000-E	40	50.75	40.19	47.25	1.625	36	3.250	622.3
PF4200-E	42	53.00	42.19	49.50	1.625	36	3.375	697.6
PF4400-E	44	55.25	44.19	51.75	1.625	40	3.375	742.7
PF4600-E	46	57.25	46.19	53.75	1.625	40	3.438	790.2
PF4800-E	48	59.50	48.19	56.00	1.625	44	3.500	853.6
PF5000-E	50	61.75	50.19	58.25	1.875	44	3.500	882.7
PF5200-E	52	64.00	52.19	60.50	1.875	44	3.625	977.1
PF5400-E	54	66.25	54.19	62.75	1.875	44	3.750	1077.6
PF6000-E	60	73.00	60.19	69.25	1.875	52	3.875	1307.4
PF6600-E	66	80.00	66.19	76.00	1.875	52	4.250	1729.0
PF7200-E	72	86.50	72.19	82.50	1.875	60	4.375	1997.0
PF7800-E	78	93.00	78.19	89.00	2.125	64	4.750	2364.5
PF8400-E	84	99.75	84.19	95.50	2.125	64	4.750	2709.1
PF9000-E	90	106.50	90.19	102.00	2.438	68	5.125	3208.8
PF9600-E	96	113.25	96.19	108.50	2.438	68	5.125	3624.3
PF10200-E	102	120.00	102.19	114.50	2.688	72	5.500	4221.1
PF10800-E	108	126.75	108.19	120.75	2.688	72	5.500	4713.8
PF11400-E	114	133.50	114.19	126.75	2.938	76	5.875	5413.8
PF12000-E	120	140.25	120.19	132.75	2.938	76	5.875	5990.1
PF12600-E	126	147.00	126.19	139.25	3.188	80	6.250	6799.2
PF13200-E	132	153.75	132.19	145.75	3.188	80	6.250	8062.8
PF14400-E	144	167.25	144.19	158.25	3.438	84	6.750	9346.0

Notes:

- a. Steel material conforms to the requirements of AWWA C207 specifications. Other material is available upon request.
- b. Meets ANSI class 150 pattern.
- c. For flanges in smaller sizes see page 4.2.

Pressure Ratings: 275psi at atmospheric temperature.

ALL DIMENSIONS ARE IN INCHES UNLESS OTHERWISE STATED.

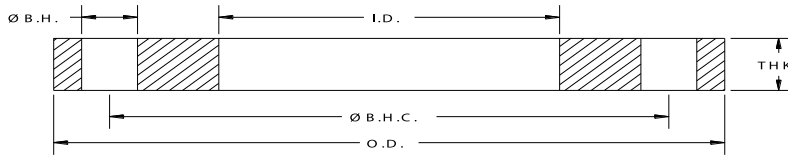

AWWA Class “E” C207 Steel-Ring Overbore Flanges [275 psi]

API Part Number	Size	O.D.	I.D.	Ø B.H.C.	Ø B.H.	# B.H.	THK	Weight Lbs
PFOB1400-1613-E	14	21.00	16.13	18.75	1.125	12	1.875	69.0
PFOB1600-1813-E	16	23.50	18.13	21.25	1.130	16	2.000	120.0
PFOB1800-1988-E	18	25.00	19.88	22.75	1.250	16	2.130	97.0
PFOB1800-2013-E	18	25.00	20.13	22.75	1.250	16	2.130	125.0
PFOB2000-2188-E	20	27.50	21.88	25.00	1.250	20	2.380	168.0
PFOB2400-2588-E	24	32.00	25.88	29.50	1.375	20	2.625	234.0
PFOB2400-2594-E	24	32.00	25.94	29.50	1.380	20	2.630	235.0
PFOB2400-2613-E	24	32.00	26.13	29.50	1.380	20	2.630	234.0
PFOB3000-3200-E	30	38.75	32.00	36.00	1.380	28	2.880	341.0
PFOB3000-3206-E	30	38.75	32.06	36.00	1.375	28	2.880	341.0
PFOB3600-3800-E	36	46.00	38.00	42.75	1.630	32	3.130	499.0
PFOB4200-4400-E	42	53.00	44.00	49.50	1.630	36	3.380	698.0
PFOB4800-5000-E	48	59.50	50.00	56.00	1.630	44	3.500	854.0

Notes:

- a. Steel material conforms to the requirements of AWWA C207 specifications. Other material is available upon request.
- b. Meets ANSI/ASME B16.5 Class 150 drilling pattern.
- c. Pressure Ratings: 275 psi. for all sizes at atmospheric temperature.

ALL DIMENSIONS ARE IN INCHES UNLESS OTHERWISE STATED.

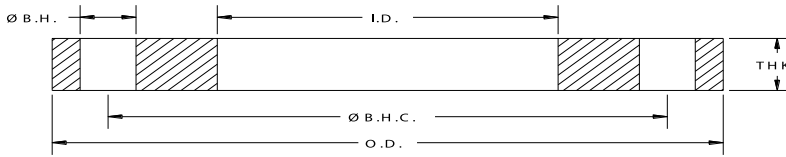

AWWA Class “F” C207 Steel-Ring Flanges [300 psi]

API Part Number	Size	O.D.	I.D.	Ø B.H.C.	Ø B.H.	# B.H.	THK	Weight Lbs
PF0400-F	4	10.00	4.57	7.88	0.875	8	1.130	18.4
PF0500-F	5	11.00	5.66	9.25	0.875	8	1.210	22.3
PF0600-F	6	12.50	6.73	10.62	0.875	12	1.310	29.7
PF0800-F	8	15.00	8.73	13.00	1.000	12	1.310	39.9
PF1000-F	10	17.50	10.88	15.25	1.125	16	1.500	56.0
PF1200-F	12	20.50	12.88	17.75	1.250	16	1.630	83.2
PF1400-F	14	23.00	14.19	20.25	1.250	20	1.940	128.0
PF1600-F	16	25.50	16.19	22.50	1.375	20	2.140	166.8
PF1800-F	18	28.00	18.19	24.75	1.375	24	2.250	204.2
PF2000-F	20	30.50	20.19	27.00	1.375	24	2.330	247.4
PF2200-F	22	33.00	22.19	29.25	1.375	24	2.500	306.7
PF2400-F	24	36.00	24.19	32.00	1.625	24	2.690	387.6
PF2600-F	26	38.25	26.19	34.50	1.875	28	3.000	451.0
PF2800-F	28	40.75	28.19	37.00	1.875	28	3.130	532.2
PF3000-F	30	43.00	30.19	39.25	1.875	28	3.150	585.7
PF3200-F	32	45.25	32.19	41.50	1.875	28	3.250	657.5
PF3400-F	34	47.50	34.19	43.50	1.875	28	3.380	743.0
PF3600-F	36	50.00	36.19	46.00	2.125	32	3.460	801.9
PF3800-F	38	52.25	38.19	48.00	2.125	32	3.500	874.3
PF4000-F	40	54.25	40.19	50.25	2.125	36	3.630	937.4
PF4200-F	42	57.00	42.19	52.75	2.125	36	3.810	1103.4
PF4400-F	44	59.25	44.19	55.00	2.125	36	4.000	1237.2
PF4600-F	46	61.50	46.19	57.25	2.125	40	4.130	1360.8
PF4800-F	48	65.00	48.19	60.75	2.125	40	4.500	1736.8

Notes:

- a. Steel material conforms to the requirements of AWWA C207 specifications. Other material is available upon request.
- b. Meets ANSI class 300 pattern.

Pressure Ratings: 300psi at atmospheric temperature.

ALL DIMENSIONS ARE IN INCHES UNLESS OTHERWISE STATED.

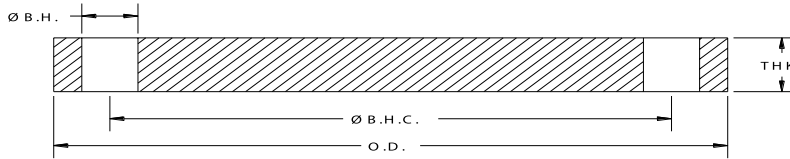

AWWA Class “B” Steel Blind Flanges - 2013 Specs [86 psi]

API Part Number	Size	O.D.	I.D.	Ø B.H.C.	Ø B.H.	# B.H.	THK	Weight Lbs
PFBL0400-B	4	9.00	BLIND	7.50	0.750	8	0.625	10.6
PFBL0500-B	5	10.00	BLIND	8.50	0.875	8	0.625	13.0
PFBL0600-B	6	11.00	BLIND	9.50	0.875	8	0.688	17.6
PFBL0800-B	8	13.50	BLIND	11.75	0.875	8	0.688	27.0
PFBL1000-B	10	16.00	BLIND	14.25	1.000	12	0.688	38.5
PFBL1200-B	12	19.00	BLIND	17.00	1.000	12	0.719	67.0
PFBL1400-B	14	21.00	BLIND	18.75	1.125	12	0.791	80.0
PFBL1600-B	16	23.50	BLIND	21.25	1.125	16	0.892	105.0
PFBL1800-B	18	25.00	BLIND	22.75	1.250	16	0.950	132.0
PFBL2000-B	20	27.50	BLIND	25.00	1.250	20	1.040	186.0
PFBL2200-B	22	29.50	BLIND	27.25	1.375	20	1.132	209.0
PFBL2400-B	24	32.00	BLIND	29.50	1.375	20	1.216	268.0
PFBL2600-B	26	34.25	BLIND	31.75	1.375	24	1.307	328.0
PFBL2800-B	28	36.50	BLIND	34.00	1.375	28	1.398	397.0
PFBL3000-B	30	38.75	BLIND	36.00	1.375	28	1.477	488.0
PFBL3200-B	32	41.75	BLIND	38.50	1.625	28	1.581	586.0
PFBL3400-B	34	43.75	BLIND	40.50	1.625	32	1.661	675.0
PFBL3600-B	36	46.00	BLIND	42.75	1.625	32	1.751	790.0
PFBL3800-B	38	48.75	BLIND	45.25	1.625	32	1.853	944.0
PFBL4000-B	40	50.75	BLIND	47.25	1.625	36	1.933	1066.0
PFBL4200-B	42	53.00	BLIND	49.50	1.625	36	2.023	1220.0
PFBL4400-B	44	55.25	BLIND	51.75	1.625	40	2.114	1385.0
PFBL4600-B	46	57.25	BLIND	53.75	1.625	40	2.194	1547.0
PFBL4800-B	48	59.50	BLIND	56.00	1.625	44	2.285	1739.0
PFBL5000-B	50	61.75	BLIND	58.25	1.875	44	2.377	1934.0
PFBL5200-B	52	64.00	BLIND	60.50	1.875	44	2.468	2163.0
PFBL5400-B	54	66.25	BLIND	62.75	1.875	44	2.559	2408.0
PFBL6000-B	60	73.00	BLIND	69.25	1.875	52	2.820	3225.0
PFBL6600-B	66	80.00	BLIND	76.00	1.875	52	3.092	4272.0
PFBL7200-B	72	86.50	BLIND	82.50	1.875	60	3.353	5418.0

Notes:

- a. Steel material conforms to the requirements of AWWA C207 specifications. Other material is available upon request.
- b. Meets ANSI class 150 pattern.
- c. AWWA recommends the use of Dish Assemblies for sizes above 72". Call API customer service for additional information.

Pressure Ratings: 86psi at atmospheric temperature.

ALL DIMENSIONS ARE IN INCHES UNLESS OTHERWISE STATED.

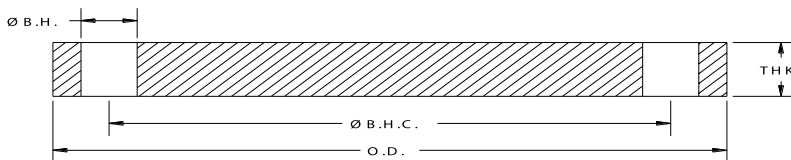

AWWA Class “D” Steel Blind Flanges [150-175 psi]

API Part Number	Size	O.D.	I.D.	Ø B.H.C.	Ø B.H.	# B.H.	THK	Weight Lbs
PFBL0400-D	4	9.00	BLIND	7.50	0.750	8	0.625	10.6
PFBL0500-D	5	10.00	BLIND	8.50	0.875	8	0.650	13.6
PFBL0600-D	6	11.00	BLIND	9.50	0.875	8	0.693	17.7
PFBL0800-D	8	13.50	BLIND	11.75	0.875	8	0.812	31.8
PFBL1000-D	10	16.00	BLIND	14.25	1.000	12	0.953	51.7
PFBL1200-D	12	19.00	BLIND	17.00	1.000	12	1.117	86.7
PFBL1400-D	14	21.00	BLIND	18.75	1.125	12	1.133	107.4
PFBL1600-D	16	23.50	BLIND	21.25	1.125	16	1.265	149.8
PFBL1800-D	18	25.00	BLIND	22.75	1.250	16	1.331	177.7
PFBL2000-D	20	27.50	BLIND	25.00	1.250	20	1.448	233.6
PFBL2200-D	22	29.50	BLIND	27.25	1.375	20	1.568	290.5
PFBL2400-D	24	32.00	BLIND	29.50	1.375	20	1.661	364.5
PFBL2600-D	26	34.25	BLIND	31.75	1.375	24	1.786	448.2
PFBL2800-D	28	36.50	BLIND	34.00	1.375	28	1.906	542.6
PFBL3000-D	30	38.75	BLIND	36.00	1.375	28	2.008	647.3
PFBL3200-D	32	41.75	BLIND	38.50	1.625	28	2.150	798.6
PFBL3400-D	34	43.75	BLIND	40.50	1.625	32	2.252	916.9
PFBL3600-D	36	46.00	BLIND	42.75	1.625	32	2.370	1071.4
PFBL3800-D	38	48.75	BLIND	45.25	1.625	32	2.506	1278.2
PFBL4000-D	40	50.75	BLIND	47.25	1.625	36	2.609	1440.1
PFBL4200-D	42	53.00	BLIND	49.50	1.625	36	2.729	1648.1
PFBL4400-D	44	55.25	BLIND	51.75	1.625	40	2.849	1868.2
PFBL4600-D	46	57.25	BLIND	53.75	1.625	40	2.952	2083.7
PFBL4800-D	48	59.50	BLIND	56.00	1.625	44	3.072	2340.7
PFBL5000-D	50	61.75	BLIND	58.25	1.875	44	3.196	2601.9
PFBL5200-D	52	64.00	BLIND	60.50	1.875	44	3.315	2907.5
PFBL5400-D	54	66.25	BLIND	62.75	1.875	44	3.435	3236.7
PFBL6000-D	60	73.00	BLIND	69.25	1.875	52	3.779	4327.6
PFBL6600-D	66	80.00	BLIND	76.00	1.875	52	4.136	5722.2
PFBL7200-D	72	86.50	BLIND	82.50	1.875	60	4.480	7249.0

Notes:

- a. Steel material conforms to the requirements of AWWA C207 specifications. Other material is available upon request.
- b. Meets ANSI class 150 pattern.
- c. AWWA recommends the use of Dish Assemblies for sizes above 72". Call API customer service for additional information.

**Pressure Ratings: 175psi (4" - 12") and 150psi (14" and larger) at atmospheric temperature.
 ALL DIMENSIONS ARE IN INCHES UNLESS OTHERWISE STATED.**

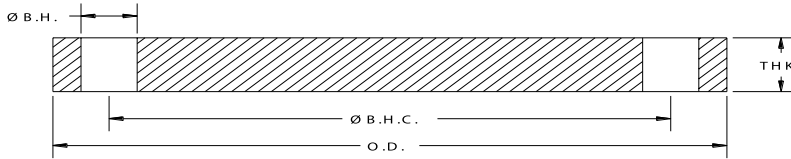

AWWA Class “E” Steel Blind Flanges [275 psi]

API Part Number	Size	O.D.	I.D.	Ø B.H.C.	Ø B.H.	# B.H.	THK	Weight Lbs
PFBL0400-E	4	9.00	BLIND	7.50	0.750	8	1.125	19.2
PFBL0500-E	5	10.00	BLIND	8.50	0.875	8	1.188	24.8
PFBL0600-E	6	11.00	BLIND	9.50	0.875	8	1.313	33.6
PFBL0800-E	8	13.50	BLIND	11.75	0.875	8	1.500	58.8
PFBL1000-E	10	16.00	BLIND	14.25	1.000	12	1.563	84.9
PFBL1200-E	12	19.00	BLIND	17.00	1.000	12	1.750	135.9
PFBL1400-E	14	21.00	BLIND	18.75	1.125	12	1.875	177.7
PFBL1600-E	16	23.50	BLIND	21.25	1.125	16	2.000	236.8
PFBL1800-E	18	25.00	BLIND	22.75	1.250	16	2.125	283.7
PFBL2000-E	20	27.50	BLIND	25.00	1.250	20	2.375	383.2
PFBL2200-E	22	29.50	BLIND	27.25	1.375	20	2.500	463.1
PFBL2400-E	24	32.00	BLIND	29.50	1.375	20	2.625	576.1
PFBL2600-E	26	34.25	BLIND	31.75	1.375	24	2.750	690.1
PFBL2800-E	28	36.50	BLIND	34.00	1.375	28	2.750	782.9
PFBL3000-E	30	38.75	BLIND	36.00	1.375	28	2.875	926.8
PFBL3200-E	32	41.75	BLIND	38.50	1.625	28	3.000	1114.3
PFBL3400-E	34	43.75	BLIND	40.50	1.625	32	3.050	1241.8
PFBL3600-E	36	46.00	BLIND	42.75	1.625	32	3.209	1450.7
PFBL3800-E	38	48.75	BLIND	45.25	1.625	32	3.394	1731.1
PFBL4000-E	40	50.75	BLIND	47.25	1.625	36	3.533	1950.2
PFBL4200-E	42	53.00	BLIND	49.50	1.625	36	3.695	2231.5
PFBL4400-E	44	55.25	BLIND	51.75	1.625	40	3.857	2529.4
PFBL4600-E	46	57.25	BLIND	53.75	1.625	40	3.997	2821.3
PFBL4800-E	48	59.50	BLIND	56.00	1.625	44	4.159	3169.0
PFBL5000-E	50	61.75	BLIND	58.25	1.875	44	4.327	3522.6
PFBL5200-E	52	64.00	BLIND	60.50	1.875	44	4.489	3937.1
PFBL5400-E	54	66.25	BLIND	62.75	1.875	44	4.651	4382.5
PFBL6000-E	60	73.00	BLIND	69.25	1.875	52	5.116	5858.7
PFBL6600-E	66	80.00	BLIND	76.00	1.875	52	5.601	7749.0
PFBL7200-E	72	86.50	BLIND	82.50	1.875	60	6.066	9815.3

Notes:

- a. Steel material conforms to the requirements of AWWA C207 specifications. Other material is available upon request.
- b. Meets ANSI class 150 pattern.
- c. AWWA recommends the use of Dish Assemblies for sizes above 72". Call API customer service for additional information.

Pressure Ratings: 275psi at atmospheric temperature.

ALL DIMENSIONS ARE IN INCHES UNLESS OTHERWISE STATED.

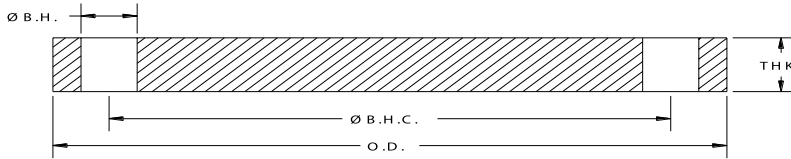

AWWA Class “F” Steel Blind Flanges [300 psi]

API Part Number	Size	O.D.	I.D.	Ø B.H.C.	Ø B.H.	# B.H.	THK	Weight Lbs
PFBL0400-F	4	10.00	BLIND	7.88	0.875	8	1.130	23.6
PFBL0500-F	5	11.00	BLIND	9.25	0.875	8	1.210	30.9
PFBL0600-F	6	12.50	BLIND	10.62	0.875	12	1.310	42.9
PFBL0800-F	8	15.00	BLIND	13.00	1.000	12	1.310	62.1
PFBL1000-F	10	17.50	BLIND	15.25	1.125	16	1.500	95.5
PFBL1200-F	12	20.50	BLIND	17.75	1.250	16	1.630	143.4
PFBL1400-F	14	23.00	BLIND	20.25	1.250	20	1.940	214.9
PFBL1600-F	16	25.50	BLIND	22.50	1.375	20	2.140	291.7
PFBL1800-F	18	28.00	BLIND	24.75	1.375	24	2.250	369.8
PFBL2000-F	20	30.50	BLIND	27.00	1.375	24	2.330	458.8
PFBL2200-F	22	33.00	BLIND	29.25	1.375	24	2.500	580.6
PFBL2400-F	24	36.00	BLIND	32.00	1.625	24	2.690	737.9
PFBL2600-F	26	38.25	BLIND	34.50	1.875	28	3.000	911.0
PFBL2800-F	28	40.75	BLIND	37.00	1.875	28	3.130	1088.0
PFBL3000-F	30	43.00	BLIND	39.25	1.875	28	3.166	1233.3
PFBL3200-F	32	45.25	BLIND	41.50	1.875	28	3.332	1445.2
PFBL3400-F	34	47.50	BLIND	43.50	1.875	28	3.475	1668.6
PFBL3600-F	36	50.00	BLIND	46.00	2.125	32	3.671	1924.2
PFBL3800-F	38	52.25	BLIND	48.00	2.125	32	3.815	2195.0
PFBL4000-F	40	54.25	BLIND	50.25	2.125	36	3.982	2463.8
PFBL4200-F	42	57.00	BLIND	52.75	2.125	36	4.171	2864.7
PFBL4400-F	44	59.25	BLIND	55.00	2.125	36	4.338	3231.9
PFBL4600-F	46	61.50	BLIND	57.25	2.125	40	4.505	3628.7
PFBL4800-F	48	65.00	BLIND	60.75	2.125	40	4.781	4322.1

Notes:

- a. Steel material conforms to the requirements of AWWA C207 specifications. Other material is available upon request.
- b. Meets ANSI class 300 pattern.

Pressure Ratings: 300psi at atmospheric temperature.

ALL DIMENSIONS ARE IN INCHES UNLESS OTHERWISE STATED.

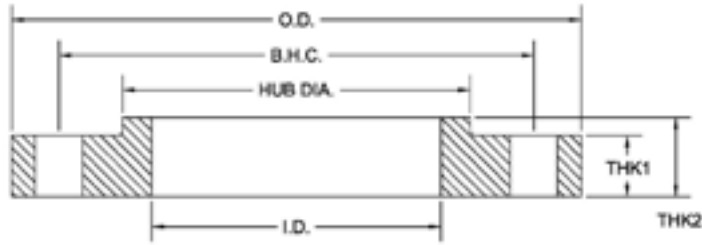

AWWA Class “D” Steel Hub Ring Flange [150-175 psi]

API Part Number	Size	O.D.	I.D.	∅ B.H.C.	∅ B.H.	# B.H.	THK1	THK2	H.D.	Weight Lbs
PF0400-D-H	4	9.00	4.57	7.50	0.750	8	0.500	0.875	5.312	6.8
PF0500-D-H	5	10.00	5.66	8.50	0.875	8	0.562	1.250	6.312	8.9
PF0600-D-H	6	11.00	6.72	9.50	0.875	8	0.562	1.250	7.562	10.5
PF0800-D-H	8	13.50	8.72	11.75	0.875	8	0.562	1.250	9.688	15.2
PF1000-D-H	10	16.00	10.88	14.25	1.000	12	0.688	1.250	12.000	22.4
PF1200-D-H	12	19.00	12.88	17.00	1.000	12	0.688	1.250	14.375	33.1
PF1400-D-H	14	21.00	14.19	18.75	1.125	12	0.750	1.250	15.750	42.6
PF1600-D-H	16	23.50	16.19	21.25	1.125	16	0.750	1.250	18.000	51.9
PF1800-D-H	18	25.00	18.19	22.75	1.250	16	0.750	1.250	19.875	52.0
PF2000-D-H	20	27.50	20.19	25.00	1.250	20	0.750	1.250	22.000	61.4
PF2200-D-H	22	29.50	22.19	27.25	1.375	20	1.000	1.750	24.250	91.5
PF2400-D-H	24	32.00	24.19	29.50	1.375	20	1.000	1.750	26.125	105.0
PF2600-D-H	26	34.25	26.19	31.75	1.375	24	1.000	1.750	28.500	119.0
PF2800-D-H	28	36.50	28.19	34.00	1.375	28	1.000	1.750	30.500	129.0
PF3000-D-H	30	38.75	30.19	36.00	1.375	28	1.000	1.750	32.500	143.0
PF3200-D-H	32	41.75	32.19	38.50	1.625	28	1.125	1.750	34.750	180.0
PF3400-D-H	34	43.75	34.19	40.50	1.625	32	1.125	1.750	36.750	189.0
PF3600-D-H	36	46.00	36.19	42.75	1.625	32	1.125	1.750	38.750	206.0
PF3800-D-H	38	48.75	38.19	45.25	1.625	32	1.125	1.750	40.750	236.0
PF4000-D-H	40	50.75	40.19	47.25	1.625	36	1.125	1.750	43.000	247.0
PF4200-D-H	42	53.00	42.19	49.50	1.625	36	1.250	1.750	45.000	285.0
PF4400-D-H	44	55.25	44.19	51.75	1.625	40	1.250	2.250	47.000	333.0
PF4600-D-H	46	57.25	46.19	53.75	1.625	40	1.250	2.250	49.000	348.0
PF4800-D-H	48	59.50	48.19	56.00	1.625	44	1.375	2.500	51.000	404.0
PF5000-D-H	50	61.75	50.19	58.25	1.875	44	1.375	2.500	53.000	420.0
PF5200-D-H	52	64.00	52.19	60.50	1.875	44	1.375	2.500	55.000	447.0
PF5400-D-H	54	66.25	54.19	62.75	1.875	44	1.375	2.500	57.000	472.0
PF6000-D-H	60	73.00	60.19	69.25	1.875	52	1.500	2.750	63.000	604.0
PF6600-D-H	66	80.00	66.19	76.00	1.875	52	1.500	2.750	69.000	717.0
PF7200-D-H	72	86.50	72.19	82.50	1.875	60	1.500	2.750	75.000	801.0
PF7800-D-H	78	93.00	78.19	89.00	2.125	64	1.750	3.000	81.250	1009.0
PF8400-D-H	84	99.75	84.19	95.50	2.125	64	1.750	3.000	87.500	1158.0
PF9000-D-H	90	106.50	90.19	102.00	2.438	68	2.000	3.200	93.750	1430.0
PF9600-D-H	96	113.25	96.19	108.50	2.438	68	2.000	3.250	100.000	1625.0

Notes:

- a. Steel material conforms to the requirements of AWWA C207 specifications. Other material is available upon request.
- b. Meets ANSI class 150 pattern.

Pressure Ratings: 175psi (4" – 12") 150psi (14" and larger) at atmospheric temperature.

ALL DIMENSIONS ARE IN INCHES UNLESS OTHERWISE STATED.

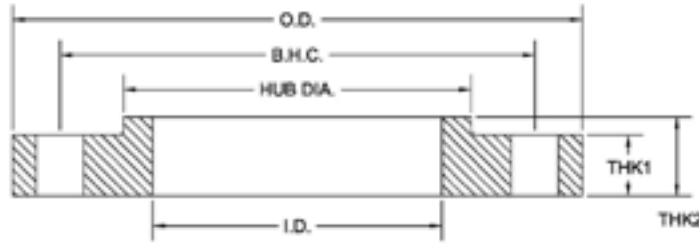

AWWA Class “E” Steel Hub Ring Flange [275 psi]

API Part Number	Size	O.D.	I.D.	∅ B.H.C.	∅ B.H.	# B.H.	THK1	THK2	H.D.	Weight Lbs
PF0400-E-H	4	9.00	4.57	7.50	0.750	8	0.938	1.312	5.312	12.2
PF0500-E-H	5	10.00	5.66	8.50	0.875	8	0.938	1.438	6.438	13.9
PF0600-E-H	6	11.00	6.72	9.50	0.875	8	1.000	1.562	7.562	17.0
PF0800-E-H	8	13.50	8.72	11.75	0.875	8	1.125	1.750	9.688	27.5
PF1000-E-H	10	16.00	10.88	14.25	1.000	12	1.188	1.938	12.000	37.4
PF1200-E-H	12	19.00	12.88	17.00	1.000	12	1.250	2.188	14.375	59.4
PF1400-E-H	14	21.00	14.19	18.75	1.125	12	1.375	2.250	15.750	77.7
PF1600-E-H	16	23.50	16.19	21.25	1.125	16	1.438	2.500	18.000	100.0
PF1800-E-H	18	25.00	18.19	22.75	1.250	16	1.562	2.688	19.875	109.0
PF2000-E-H	20	27.50	20.19	25.00	1.250	20	1.688	2.875	22.000	139.0
PF2200-E-H	22	29.50	22.19	27.25	1.375	20	1.812	3.125	24.000	161.0
PF2400-E-H	24	32.00	24.19	29.50	1.375	20	1.875	3.250	26.125	198.0
PF2600-E-H	26	34.25	26.19	31.75	1.375	24	2.000	3.375	28.500	235.0
PF2800-E-H	28	36.50	28.19	34.00	1.375	28	2.062	3.438	30.750	168.0
PF3000-E-H	30	38.75	30.19	36.00	1.375	28	2.125	3.530	32.750	303.0
PF3200-E-H	32	41.75	32.19	38.50	1.625	28	2.250	3.625	35.000	375.0
PF3400-E-H	34	43.75	34.19	40.50	1.625	32	2.312	3.688	37.000	400.0
PF3600-E-H	36	46.00	36.19	42.75	1.625	32	2.375	3.750	39.250	450.0
PF3800-E-H	38	48.75	38.19	45.25	1.625	32	2.375	3.750	41.750	527.0
PF4000-E-H	40	50.75	40.19	47.25	1.625	36	2.500	3.875	43.750	570.0
PF4200-E-H	42	53.00	42.19	49.50	1.625	36	2.625	4.000	46.000	650.0
PF4400-E-H	44	55.25	44.19	51.75	1.625	40	2.625	4.000	48.000	687.0
PF4600-E-H	46	57.25	46.19	53.75	1.625	40	2.688	4.062	50.000	732.0
PF4800-E-H	48	59.50	48.19	56.00	1.625	44	2.750	4.125	52.250	800.0
PF5000-E-H	50	61.75	50.19	58.25	1.875	44	2.750	4.125	54.250	826.0
PF5200-E-H	52	64.00	52.19	60.50	1.875	44	2.875	4.250	56.500	921.0
PF5400-E-H	54	66.25	54.19	62.75	1.875	44	3.000	4.375	58.750	1022.0
PF6000-E-H	60	73.00	60.19	69.25	1.875	52	3.125	4.500	65.250	1252.0
PF6600-E-H	66	80.00	66.19	76.00	1.875	52	3.375	4.875	71.500	1621.0
PF7200-E-H	72	86.50	72.19	82.50	1.875	60	3.500	5.000	78.500	1919.0
PF7800-E-H	78	93.00	78.19	89.00	2.125	64	3.875	5.375	84.500	2277.0
PF8400-E-H	84	99.75	84.19	95.50	2.125	64	3.875	5.375	90.500	2583.0
PF9000-E-H	90	106.50	90.19	102.00	2.438	68	4.250	5.750	96.750	3076.0
PF9600-E-H	96	113.25	96.19	108.50	2.438	68	4.250	5.750	102.750	3448.0

Notes:

- a. Steel material conforms to the requirements of AWWA C207 specifications. Other material is available upon request.
- b. Meets ANSI class 150 pattern.

Pressure Ratings: 275psi at atmospheric temperature.

ALL DIMENSIONS ARE IN INCHES UNLESS OTHERWISE STATED.

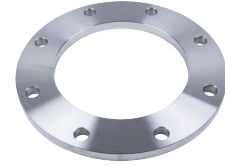
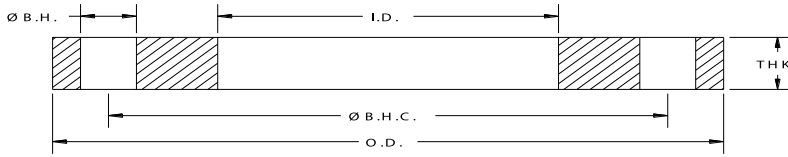

AWWA Class “SA” Stainless Steel-Ring Flanges [50psi]

API Part Number	Size	O.D.	I.D.	Ø B.H.C	Ø B.H.	# B.H	THK	Weight lbs
SPF0200-A	2	6.00	2.44	4.75	0.750	4	0.500	3.0
SPF0250-A	2.5	7.00	2.94	5.50	0.750	4	0.500	4.0
SPF0300-A	3	7.50	3.57	6.00	0.750	4	0.500	4.7
SPF0400-A	4	9.00	4.57	7.50	0.750	8	0.500	6.4
SPF0500-A	5	10.00	5.66	8.50	0.875	8	0.500	7.2
SPF0600-A	6	11.00	6.72	9.50	0.875	8	0.500	8.4
SPF0800-A	8	13.50	8.72	11.75	0.875	8	0.500	11.4
SPF1000-A	10	16.00	10.88	14.25	1.000	12	0.625	17.4
SPF1200-A	12	19.00	12.88	17.00	1.000	12	0.625	25.5
SPF1400-A	14	21.00	14.19	18.75	1.125	12	0.625	31.3

Notes:

- a. All Stainless Steel flanges available in Dual Grade 304/304L or 316/316L. Material conforms to the requirements of AWWA C228 specifications. Other material is available upon request.
- b. Meets ANSI class 150 pattern.
- c. For flanges larger than 14" see AWWA Class "B"
- d. Class SB is being sold as the recommended product for sizes 10", 12", 14" and meet/exceed the required pressure ratings for Class SA
- e. Thickness Spec's (sizes 10", 12", 14"):
 - i. AWWA Class A requires minimum .625" (+.125;-.000).
 - ii. AWWA Class B requires minimum .688" (.125; -.000).
- f. AWWA Class A acceptable thickness (sizes 10", 12", 14"): .625 -.750"
- g. **Pressure Ratings: 275psi at atmospheric temperature.**

ALL DIMENSIONS ARE IN INCHES UNLESS OTHERWISE STATED.

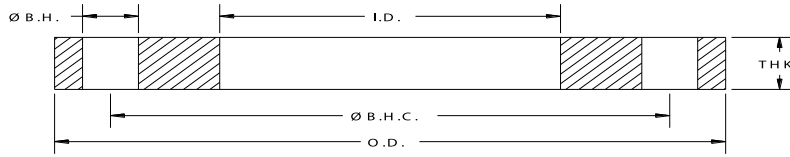

AWWA Class “SB” Stainless Steel-Ring Flanges [86 psi]

API Part Number	Size	O.D.	I.D.	Ø B.H.C.	Ø B.H.	# B.H.	THK	Weight Lbs
SPF0200-B	2	6.00	2.44	4.75	0.750	4	0.625	3.9
SPF0250-B	2.5	7.00	2.94	5.50	0.750	4	0.625	5.3
SPF0300-B	3	7.50	3.57	6.00	0.750	4	0.625	5.7
SPF0400-B	4	9.00	4.57	7.50	0.750	8	0.625	7.7
SPF0500-B	5	10.00	5.66	8.50	0.875	8	0.625	8.6
SPF0600-B	6	11.00	6.72	9.50	0.875	8	0.688	10.7
SPF0800-B	8	13.50	8.72	11.75	0.875	8	0.688	15.3
SPF1000-B	10	16.00	10.88	14.25	1.000	12	0.688	19.2
SPF1200-B	12	19.00	12.88	17.00	1.000	12	0.688	29.3
SPF1400-B	14	21.00	14.19	18.75	1.125	12	0.688	36.2
SPF1600-B	16	23.50	16.19	21.25	1.125	16	0.688	42.2
SPF1800-B	18	25.00	18.19	22.75	1.250	16	0.688	44.8
SPF2000-B	20	27.50	20.19	25.00	1.250	20	0.688	52.1
SPF2200-B	22	29.50	22.19	27.25	1.375	20	0.750	60.9
SPF2400-B	24	32.00	24.19	29.50	1.375	20	0.750	71.0
SPF2600-B	26	34.25	26.19	31.75	1.375	24	0.812	80.0
SPF2800-B	28	36.50	28.19	34.00	1.375	28	0.875	94.0
SPF3000-B	30	38.75	30.19	36.00	1.375	28	0.875	108.0
SPF3200-B	32	41.75	32.19	38.50	1.625	28	0.938	121.0
SPF3400-B	34	43.75	34.19	40.50	1.625	32	0.938	137.0
SPF3600-B	36	46.00	36.19	42.75	1.625	32	1.000	166.0
SPF3800-B	38	48.75	38.19	45.25	1.625	32	1.000	185.0
SPF4000-B	40	50.75	40.19	47.25	1.625	36	1.000	203.0
SPF4200-B	42	53.00	42.19	49.50	1.625	36	1.125	241.0
SPF4400-B	44	55.25	44.19	51.75	1.625	40	1.125	248.0
SPF4600-B	46	57.25	46.19	53.75	1.625	40	1.125	259.0
SPF4800-B	48	59.50	48.19	56.00	1.625	44	1.250	285.0
SPF5000-B	50	61.75	50.19	58.25	1.875	44	1.250	316.0
SPF5200-B	52	64.00	52.19	60.50	1.875	44	1.250	338.0
SPF5400-B	54	66.25	54.19	62.75	1.875	44	1.375	397.0
SPF6000-B	60	73.00	60.19	69.25	1.875	52	1.500	472.0

Notes

- a. All Stainless Steel flanges available in Dual Grade 304/304L or 316/316L. Material conforms to the requirements of AWWA C228 specifications. Other material is available upon request.
- b. Meets ANSI class 150 pattern.
- c. For flanges in smaller sizes see page 4.3.

Pressure Ratings: 86psi at atmospheric temperature.

ALL DIMENSIONS ARE IN INCHES UNLESS OTHERWISE STATED.

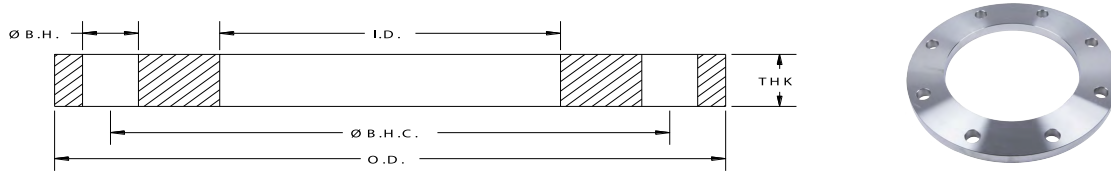

AWWA Class “SD” Stainless Steel-Ring Flanges [150-175 psi]

API Part Number	Size	O.D.	I.D.	Ø B.H.C.	Ø B.H.	# B.H.	THK	Weight Lbs
SPF0200-D	2	6.00	2.44	4.75	0.750	4	0.625	3.9
SPF0250-D	2.5	7.00	2.94	5.50	0.750	4	0.625	5.3
SPF0300-D	3	7.50	3.57	6.00	0.750	4	0.625	5.7
SPF0400-D	4	9.00	4.57	7.50	0.750	8	0.625	8.1
SPF0500-D	5	10.00	5.66	8.50	0.875	8	0.625	9.1
SPF0600-D	6	11.00	6.72	9.50	0.875	8	0.688	10.7
SPF0800-D	8	13.50	8.72	11.75	0.875	8	0.688	15.7
SPF1000-D	10	16.00	10.88	14.25	1.000	12	0.688	19.3
SPF1200-D	12	19.00	12.88	17.00	1.000	12	0.812	33.9
SPF1400-D	14	21.00	14.19	18.75	1.125	12	0.938	47.3
SPF1600-D	16	23.50	16.19	21.25	1.125	16	1.000	60.8
SPF1800-D	18	25.00	18.19	22.75	1.250	16	1.062	65.2
SPF2000-D	20	27.50	20.19	25.00	1.250	20	1.125	81.2
SPF2200-D	22	29.50	22.19	27.25	1.375	20	1.188	90.8
SPF2400-D	24	32.00	24.19	29.50	1.375	20	1.250	112.0
SPF2600-D	26	34.25	26.19	31.75	1.375	24	1.312	132.0
SPF2800-D	28	36.50	28.19	34.00	1.375	28	1.312	148.0
SPF3000-D	30	38.75	30.19	36.00	1.375	28	1.375	169.0
SPF3200-D	32	41.75	32.19	38.50	1.625	28	1.500	211.0
SPF3400-D	34	43.75	34.19	40.50	1.625	32	1.500	219.0
SPF3600-D	36	46.00	36.19	42.75	1.625	32	1.625	265.0
SPF3800-D	38	48.75	38.19	45.25	1.625	32	1.625	300.0
SPF4000-D	40	50.75	40.19	47.25	1.625	36	1.625	311.0
SPF4200-D	42	53.00	42.19	49.50	1.625	36	1.750	362.0
SPF4400-D	44	55.25	44.19	51.75	1.625	40	1.750	385.0
SPF4600-D	46	57.25	46.19	53.75	1.625	40	1.750	404.0
SPF4800-D	48	59.50	48.19	56.00	1.625	44	1.875	457.0
SPF5000-D	50	61.75	50.19	58.25	1.875	44	2.000	505.0
SPF5200-D	52	64.00	52.19	60.50	1.875	44	2.000	539.0
SPF5400-D	54	66.25	54.19	62.75	1.875	44	2.125	611.0
SPF6000-D	60	73.00	60.19	69.25	1.875	52	2.250	760.0

Notes:

- a. All Stainless Steel flanges available in Dual Grade 304/304L or 316/316L. Material conforms to the requirements of AWWA C228 specifications. Other material is available upon request.
- b. Meets ANSI class 150 pattern.
- c. For flanges in smaller sizes see page 4.3.

Pressure Ratings: 175psi (4" - 12") and 150psi (14" and larger) at atmospheric temperature.
ALL DIMENSIONS ARE IN INCHES UNLESS OTHERWISE STATED.

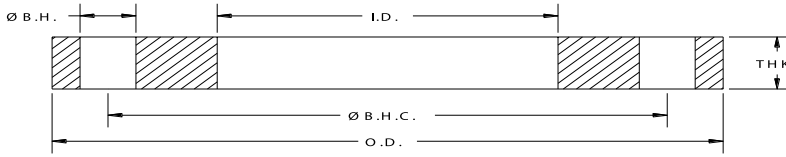

AWWA Class “SE” Stainless Steel-Ring Flanges [275 psi]

API Part Number	Size	O.D.	I.D.	Ø B.H.C.	Ø B.H.	# B.H.	THK	Weight Lbs
SPF0200-E	2	6.00	2.44	4.75	0.750	4	1.125	6.9
SPF0250-E	2.5	7.00	2.94	5.50	0.750	4	1.125	9.5
SPF0300-E	3	7.50	3.57	6.00	0.750	4	1.125	10.3
SPF0400-E	4	9.00	4.57	7.50	0.750	8	1.125	14.1
SPF0500-E	5	10.00	5.66	8.50	0.875	8	1.188	16.7
SPF0600-E	6	11.00	6.72	9.50	0.875	8	1.313	21.1
SPF0800-E	8	13.50	8.72	11.75	0.875	8	1.500	34.4
SPF1000-E	10	16.00	10.88	14.25	1.000	12	1.563	45.9
SPF1200-E	12	19.00	12.88	17.00	1.000	12	1.750	72.3
SPF1400-E	14	21.00	14.19	18.75	1.125	12	1.875	97.7
SPF1600-E	16	23.50	16.19	21.25	1.125	16	2.000	123.4
SPF1800-E	18	25.00	18.19	22.75	1.250	16	2.125	130.0
SPF2000-E	20	27.50	20.19	25.00	1.250	20	2.375	171.0
SPF2200-E	22	29.50	22.19	27.25	1.375	20	2.500	189.0
SPF2400-E	24	32.00	24.19	29.50	1.375	20	2.625	234.0
SPF2600-E	26	34.25	26.19	31.75	1.375	24	2.750	270.0
SPF2800-E	28	36.50	28.19	34.00	1.375	28	2.750	296.0
SPF3000-E	30	38.75	30.19	36.00	1.375	28	2.875	350.0
SPF3200-E	32	41.75	32.19	38.50	1.625	28	3.000	396.0
SPF3400-E	34	43.75	34.19	40.50	1.625	32	3.000	440.0
SPF3600-E	36	46.00	36.19	42.75	1.625	32	3.125	511.0
SPF3800-E	38	48.75	38.19	45.25	1.625	32	3.125	579.0
SPF4000-E	40	50.75	40.19	47.25	1.625	36	3.250	625.0
SPF4200-E	42	53.00	42.19	49.50	1.625	36	3.375	689.0
SPF4400-E	44	55.25	44.19	51.75	1.625	40	3.375	746.0
SPF4600-E	46	57.25	46.19	53.75	1.625	40	3.438	799.0
SPF4800-E	48	59.50	48.19	56.00	1.625	44	3.500	857.0
SPF5000-E	50	61.75	50.19	58.25	1.875	44	3.500	886.0
SPF5200-E	52	64.00	52.19	60.50	1.875	44	3.625	992.0
SPF5400-E	54	66.25	54.19	62.75	1.875	44	3.750	1082.0
SPF6000-E	60	73.00	60.19	69.25	1.875	52	3.875	1312.0
SPF6600-E	66	80.00	66.19	76.00	1.875	52	4.250	1735.0
SPF7200-E	72	86.50	72.19	82.50	1.875	60	4.375	2004.0

Notes:

- a. All Stainless Steel flanges available in Dual Grade 304/304L or 316/316L. Material conforms to the requirements of AWWA C228 specifications. Other material is available upon request.
- b. Meets ANSI class 150 pattern.
- c. For flanges in smaller sizes see page 4.3.

Pressure Ratings: 275psi at atmospheric temperature.

ALL DIMENSIONS ARE IN INCHES UNLESS OTHERWISE STATED.

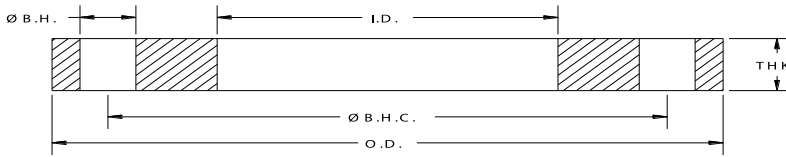

AWWA Class “SF” Stainless Steel-Ring Flanges [300 psi]

API Part Number	Size	O.D.	I.D.	Ø B.H.C.	Ø B.H.	# B.H.	THK	Weight Lbs
SPF0400-F	4	10.00	4.57	7.88	0.875	8	1.130	18.4
SPF0500-F	5	11.00	5.66	9.25	0.875	8	1.210	22.3
SPF0600-F	6	12.50	6.72	10.62	0.875	12	1.310	29.7
SPF0800-F	8	15.00	8.72	13.00	1.000	12	1.310	39.9
SPF1000-F	10	17.50	10.88	15.25	1.125	16	1.500	56.0
SPF1200-F	12	20.50	12.88	17.75	1.250	16	1.630	84.9
SPF1400-F	14	23.00	14.19	20.25	1.250	20	1.940	127.0
SPF1600-F	16	25.50	16.19	22.50	1.375	20	2.140	166.0
SPF1800-F	18	28.00	18.19	24.75	1.375	24	2.250	205.0
SPF2000-F	20	30.50	20.19	27.00	1.375	24	2.330	247.0
SPF2200-F	22	33.00	22.19	29.25	1.375	24	2.500	307.0
SPF2400-F	24	36.00	24.19	32.00	1.625	24	2.690	388.0
SPF2600-F	26	38.25	26.25	34.50	1.875	28	3.000	450.0
SPF2800-F	28	40.75	28.25	37.00	1.875	28	3.130	532.0
SPF3000-F	30	43.00	30.25	39.25	1.875	28	3.150	585.0
SPF3200-F	32	45.25	32.25	41.50	1.875	28	3.250	657.0
SPF3400-F	34	47.50	34.25	43.50	1.875	28	3.380	740.0
SPF3600-F	36	50.00	36.25	46.00	2.125	32	3.460	801.0
SPF3800-F	38	52.25	38.25	48.00	2.125	32	3.500	873.0
SPF4000-F	40	54.25	40.25	50.25	2.125	36	3.630	936.0
SPF4200-F	42	57.00	42.25	52.75	2.125	36	3.810	1102.0
SPF4400-F	44	59.25	44.25	55.00	2.125	36	4.000	1236.0
SPF4600-F	46	61.50	46.25	57.25	2.125	40	4.130	1343.0
SPF4800-F	48	65.00	48.25	60.75	2.125	40	4.500	1717.0

Notes:

a. All Stainless Steel flanges available in Dual Grade 304/304L or 316/316L. Material conforms to the requirements of AWWA C228 specifications. Other material is available upon request.

b. Meets ANSI class 300 pattern.

Pressure Ratings: 300 psi at atmospheric temperature.

ALL DIMENSIONS ARE IN INCHES UNLESS OTHERWISE STATED.

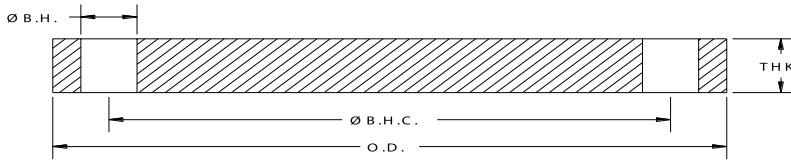

AWWA Class “SA” Stainless Steel Blind Flanges [50 psi]

API Part Number	Size	O.D.	I.D.	Ø B.H.C	Ø B.H.	# B.H	THK	Weight lbs
SPFBL0200-A	2	6.00	BLIND	4.75	0.750	4	0.500	4.0
SPFBL0250-A	2.5	7.00	BLIND	5.50	0.750	4	0.500	5.5
SPFBL0300-A	3	7.50	BLIND	6.00	0.750	4	0.500	6.2
SPFBL0350-A	3.5	8.50	BLIND	7.00	0.750	8	0.500	7.5
SPFBL0400-A	4	9.00	BLIND	7.50	0.750	8	0.500	9.1
SPFBL0500-A	5	10.00	BLIND	8.50	0.875	8	0.500	11.0
SPFBL0600-A	6	11.00	BLIND	9.50	0.875	8	0.500	14.3
SPFBL0800-A	8	13.50	BLIND	11.75	0.875	8	0.500	20.0

Notes:

- a. All Stainless Steel flanges available in Dual Grade 304/304L or 316/316L.. Material conforms to the requirements of AWWA C228 specifications. Other material is available upon request.
- b. Meets ANSI class 150 pattern.
- c. For flanges larger than 8" see AWWA Class "B"
- d. **Pressure Ratings: 275psi at atmospheric temperature.**

ALL DIMENSIONS ARE IN INCHES UNLESS OTHERWISE STATED.

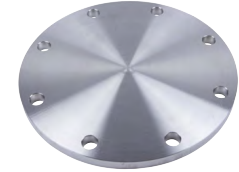
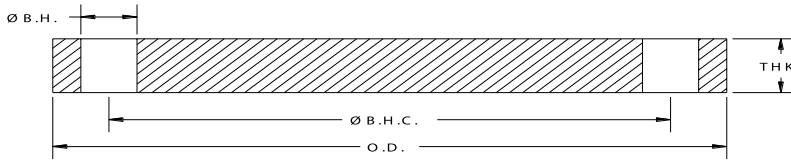

AWWA Class “SB” Stainless Steel Blind Flanges (86 psi)

API Part Number	Size	O.D.	I.D.	Ø B.H.C.	Ø B.H.	# B.H.	THK	Weight Lbs
SPFBL0400-B	4	9.00	BLIND	7.50	0.750	8	0.625	11.0
SPFBL0500-B	5	10.00	BLIND	8.50	0.875	8	0.625	13.0
SPFBL0600-B	6	11.00	BLIND	9.50	0.875	8	0.688	18.0
SPFBL0800-B	8	13.50	BLIND	11.75	0.875	8	0.688	27.0
SPFBL1000-B	10	16.00	BLIND	14.25	1.000	12	0.688	38.0
SPFBL1200-B	12	19.00	BLIND	17.00	1.000	12	0.719	56.0
SPFBL1400-B	14	21.00	BLIND	18.75	1.125	12	0.791	75.0
SPFBL1600-B	16	23.50	BLIND	21.25	1.125	16	0.892	105.0
SPFBL1800-B	18	25.00	BLIND	22.75	1.250	16	0.950	126.0
SPFBL2000-B	20	27.50	BLIND	25.00	1.250	20	1.040	167.0
SPFBL2200-B	22	29.50	BLIND	27.25	1.375	20	1.132	209.0
SPFBL2400-B	24	32.00	BLIND	29.50	1.375	20	1.216	267.0
SPFBL2600-B	26	34.25	BLIND	31.75	1.375	24	1.307	327.0
SPFBL2800-B	28	36.50	BLIND	34.00	1.375	28	1.398	397.0
SPFBL3000-B	30	38.75	BLIND	36.00	1.375	28	1.477	475.0
SPFBL3200-B	32	41.75	BLIND	38.50	1.625	28	1.581	586.0
SPFBL3400-B	34	43.75	BLIND	40.50	1.625	32	1.661	675.0
SPFBL3600-B	36	46.00	BLIND	42.75	1.625	32	1.751	790.0
SPFBL3800-B	38	48.75	BLIND	45.25	1.625	32	1.853	944.0
SPFBL4000-B	40	50.75	BLIND	47.25	1.625	36	1.933	1066.0
SPFBL4200-B	42	53.00	BLIND	49.50	1.625	36	2.023	1220.0
SPFBL4400-B	44	55.25	BLIND	51.75	1.625	40	2.114	1385.0
SPFBL4600-B	46	57.25	BLIND	53.75	1.625	40	2.194	1547.0
SPFBL4800-B	48	59.50	BLIND	56.00	1.625	44	2.285	1739.0
SPFBL5000-B	50	61.75	BLIND	58.25	1.875	44	2.377	1934.0
SPFBL5200-B	52	64.00	BLIND	60.50	1.875	44	2.468	2163.0
SPFBL5400-B	54	66.25	BLIND	62.75	1.875	44	2.559	2408.0
SPFBL6000-B	60	73.00	BLIND	69.25	1.875	52	2.820	3225.0
SPFBL6600-B	66	80.00	BLIND	76.00	1.875	52	3.092	4272.0
SPFBL7200-B	72	86.50	BLIND	82.50	1.875	60	3.353	5418.0

Notes:

- a. All Stainless Steel flanges available in Dual Grade 304/304L or 316/316L. Material conforms to the requirements of AWWA C228 specifications. Other material is available upon request.
- b. Meets ANSI class 150 pattern.
- c. AWWA recommends the use of Dish Assemblies for sizes above 72". Call API customer service for additional information.

Pressure Ratings: 86psi at atmospheric temperature.

ALL DIMENSIONS ARE IN INCHES UNLESS OTHERWISE STATED.

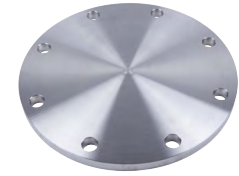
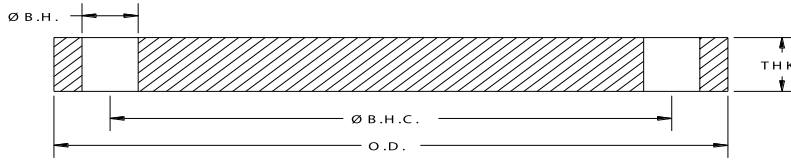

AWWA Class “SD” Stainless Steel Blind Flanges - 1986 Spec’s

API Part Number	Size	O.D.	I.D.	Ø B.H.C.	Ø B.H.	# B.H.	THK	Weight Lbs
SPFBL0400-86	4	9.00	BLIND	7.50	0.750	8	0.625	11.0
SPFBL0500-86	5	10.00	BLIND	8.50	0.875	8	0.625	13.0
SPFBL0600-86	6	11.00	BLIND	9.50	0.875	8	0.688	18.0
SPFBL0800-86	8	13.50	BLIND	11.75	0.875	8	0.688	27.0
SPFBL1000-86	10	16.00	BLIND	14.25	1.000	12	0.688	38.0
SPFBL1200-86	12	19.00	BLIND	17.00	1.000	12	0.813	64.0
SPFBL1400-86	14	21.00	BLIND	18.75	1.125	12	0.938	88.0
SPFBL1600-86	16	23.50	BLIND	21.25	1.125	16	1.000	118.0
SPFBL1800-86	18	25.00	BLIND	22.75	1.250	16	1.063	141.0
SPFBL2000-86	20	27.50	BLIND	25.00	1.250	20	1.125	181.0
SPFBL2400-86	24	32.00	BLIND	29.50	1.375	20	1.250	273.0
SPFBL3000-86	30	38.75	BLIND	36.00	1.375	28	1.375	436.0
SPFBL3600-86	36	46.00	BLIND	42.75	1.625	32	1.625	735.0
SPFBL4200-86	42	53.00	BLIND	49.50	1.625	36	1.750	1057.0
SPFBL4800-86	48	59.50	BLIND	56.00	1.625	44	1.875	1428.0
SPFBL6000-86	60	73.00	BLIND	69.25	1.875	52	2.250	2574.0

Notes:

- a. All Stainless Steel flanges available in Dual Grade 304/304L or 316/316L. Material conforms to the requirements of AWWA C228 specifications. Other material is available upon request.
- b. Meets ANSI class 150 pattern.
- c. Manufactured to AWWA C207-1986 dimensional specifications.
- d. AWWA recommends the use of Dish Assemblies for sizes above 72". Call API customer service for additional information.

ALL DIMENSIONS ARE IN INCHES UNLESS OTHERWISE STATED.

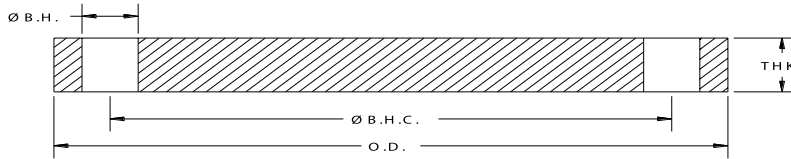

AWWA Class “SD” Stainless Steel Blind Flanges [150-175 psi]

API Part Number	Size	O.D.	I.D.	Ø B.H.C.	Ø B.H.	# B.H.	THK	Weight Lbs
SPFBL0400-D	4	9.00	BLIND	7.50	0.750	8	0.625	11.0
SPFBL0500-D	5	10.00	BLIND	8.50	0.875	8	0.650	13.0
SPFBL0600-D	6	11.00	BLIND	9.50	0.875	8	0.693	18.0
SPFBL0800-D	8	13.50	BLIND	11.75	0.875	8	0.813	31.0
SPFBL1000-D	10	16.00	BLIND	14.25	1.000	12	0.953	52.0
SPFBL1200-D	12	19.00	BLIND	17.00	1.000	12	1.117	87.0
SPFBL1400-D	14	21.00	BLIND	18.75	1.125	12	1.133	107.0
SPFBL1600-D	16	23.50	BLIND	21.25	1.125	16	1.265	150.0
SPFBL1800-D	18	25.00	BLIND	22.75	1.250	16	1.331	178.0
SPFBL2000-D	20	27.50	BLIND	25.00	1.250	20	1.448	234.0
SPFBL2200-D	22	29.50	BLIND	27.25	1.375	20	1.568	290.0
SPFBL2400-D	24	32.00	BLIND	29.50	1.375	20	1.661	365.0
SPFBL2600-D	26	34.25	BLIND	31.75	1.375	24	1.786	447.0
SPFBL2800-D	28	36.50	BLIND	34.00	1.375	28	1.906	542.0
SPFBL3000-D	30	38.75	BLIND	36.00	1.375	28	2.008	647.0
SPFBL3200-D	32	41.75	BLIND	38.50	1.625	28	2.150	798.0
SPFBL3400-D	34	43.75	BLIND	40.50	1.625	32	2.252	916.0
SPFBL3600-D	36	46.00	BLIND	42.75	1.625	32	2.370	1071.0
SPFBL3800-D	38	48.75	BLIND	45.25	1.625	32	2.506	1277.0
SPFBL4000-D	40	50.75	BLIND	47.25	1.625	36	2.609	1439.0
SPFBL4200-D	42	53.00	BLIND	49.50	1.625	36	2.729	1648.0
SPFBL4400-D	44	55.25	BLIND	51.75	1.625	40	2.849	1867.0
SPFBL4600-D	46	57.25	BLIND	53.75	1.625	40	2.952	2082.0
SPFBL4800-D	48	59.50	BLIND	56.00	1.625	44	3.072	2340.0
SPFBL5000-D	50	61.75	BLIND	58.25	1.875	44	3.196	2600.0
SPFBL5200-D	52	64.00	BLIND	60.50	1.875	44	3.315	2906.0
SPFBL5400-D	54	66.25	BLIND	62.75	1.875	44	3.435	3235.0
SPFBL6000-D	60	73.00	BLIND	69.25	1.875	52	3.779	4328.0
SPFBL6600-D	66	80.00	BLIND	76.00	1.875	52	4.136	5719.0

Notes:

- a. All Stainless Steel flanges available in Dual Grade 304/304L or 316/316L. Material conforms to the requirements of AWWA C228 specifications. Other material is available upon request.
- b. Meets ANSI class 150 pattern.
- c. AWWA recommends the use of Dish Assemblies for sizes above 72". Call API customer service for additional information.

ALL DIMENSIONS ARE IN INCHES UNLESS OTHERWISE STATED.

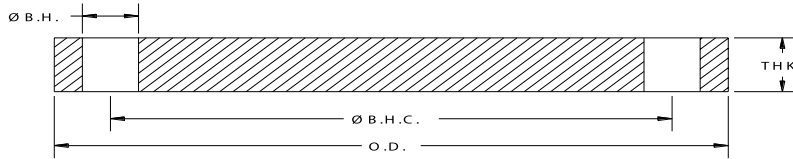

AWWA Class “SE” Stainless Steel Blind Flanges [275psi]

API Part Number	Size	O.D.	I.D.	Ø B.H.C.	Ø B.H.	# B.H.	THK	Weight Lbs
SPFBL0400-E	4	9.00	BLIND	7.50	0.750	8	1.125	19.0
SPFBL0500-E	5	10.00	BLIND	8.50	0.875	8	1.188	24.0
SPFBL0600-E	6	11.00	BLIND	9.50	0.875	8	1.313	33.0
SPFBL0800-E	8	13.50	BLIND	11.75	0.875	8	1.500	58.0
SPFBL1000-E	10	16.00	BLIND	14.25	1.000	12	1.563	84.0
SPFBL1200-E	12	19.00	BLIND	17.00	1.000	12	1.750	135.0
SPFBL1400-E	14	21.00	BLIND	18.75	1.125	12	1.875	176.0
SPFBL1600-E	16	23.50	BLIND	21.25	1.125	16	2.000	234.0
SPFBL1800-E	18	25.00	BLIND	22.75	1.250	16	2.125	283.0
SPFBL2000-E	20	27.50	BLIND	25.00	1.250	20	2.375	382.0
SPFBL2200-E	22	29.50	BLIND	27.25	1.375	20	2.500	462.0
SPFBL2400-E	24	32.00	BLIND	29.50	1.375	20	2.625	575.0
SPFBL2600-E	26	34.25	BLIND	31.75	1.375	24	2.750	689.0
SPFBL2800-E	28	36.50	BLIND	34.00	1.375	28	2.750	782.0
SPFBL3000-E	30	38.75	BLIND	36.00	1.375	28	2.875	926.0
SPFBL3200-E	32	41.75	BLIND	38.50	1.625	28	3.000	1113.0
SPFBL3400-E	34	43.75	BLIND	40.50	1.625	32	3.050	1241.0
SPFBL3600-E	36	46.00	BLIND	42.75	1.625	32	3.209	1450.0
SPFBL3800-E	38	48.75	BLIND	45.25	1.625	32	3.394	1730.0
SPFBL4000-E	40	50.75	BLIND	47.25	1.625	36	3.533	1949.0
SPFBL4200-E	42	53.00	BLIND	49.50	1.625	36	3.695	2230.0
SPFBL4400-E	44	55.25	BLIND	51.75	1.625	40	3.857	2528.0
SPFBL4600-E	46	57.25	BLIND	53.75	1.625	40	3.997	2819.0
SPFBL4800-E	48	59.50	BLIND	56.00	1.625	44	4.159	3167.0
SPFBL5000-E	50	61.75	BLIND	58.25	1.875	44	4.327	3520.0
SPFBL5200-E	52	64.00	BLIND	60.50	1.875	44	4.489	3935.0
SPFBL5400-E	54	66.25	BLIND	62.75	1.875	44	4.651	4380.0
SPFBL6000-E	60	73.00	BLIND	69.25	1.875	52	5.116	5855.0
SPFBL6600-E	66	80.00	BLIND	76.00	1.875	52	5.601	7745.0
SPFBL7200-E	72	86.50	BLIND	82.50	1.875	60	6.066	9810.0

Notes:

- a. All Stainless Steel flanges available in Dual Grade 304/304L or 316/316L. Material conforms to the requirements of AWWA C228 specifications. Other material is available upon request.
- b. Meets ANSI class 150 pattern.
- c. AWWA recommends the use of Dish Assemblies for sizes above 72". Call API customer service for additional information.

ALL DIMENSIONS ARE IN INCHES UNLESS OTHERWISE STATED.

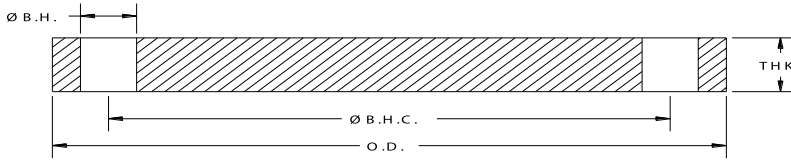

AWWA Class “SF” Stainless Steel Blind Flanges [300 psi]

API Part Number	Size	O.D.	I.D.	Ø B.H.C.	Ø B.H.	# B.H.	THK	Weight Lbs
SPFBL0400-F	4	10.00	BLIND	7.88	0.875	8	1.130	23.0
SPFBL0500-F	5	11.00	BLIND	9.25	0.875	8	1.210	31.0
SPFBL0600-F	6	12.50	BLIND	10.62	0.875	12	1.310	43.0
SPFBL0800-F	8	15.00	BLIND	13.00	1.000	12	1.310	62.0
SPFBL1000-F	10	17.50	BLIND	15.25	1.125	16	1.500	96.0
SPFBL1200-F	12	20.50	BLIND	17.75	1.250	16	1.630	143.0
SPFBL1400-F	14	23.00	BLIND	20.25	1.250	20	1.940	214.0
SPFBL1600-F	16	25.50	BLIND	22.50	1.375	20	2.140	291.0
SPFBL1800-F	18	28.00	BLIND	24.75	1.375	24	2.250	369.0
SPFBL2000-F	20	30.50	BLIND	27.00	1.375	24	2.330	458.0
SPFBL2200-F	22	33.00	BLIND	29.25	1.375	24	2.500	580.0
SPFBL2400-F	24	36.00	BLIND	32.00	1.625	24	2.690	737.0
SPFBL2600-F	26	38.25	BLIND	34.50	1.875	28	3.000	910.0
SPFBL2800-F	28	40.75	BLIND	37.00	1.875	28	3.130	1087.0
SPFBL3000-F	30	43.00	BLIND	39.25	1.875	28	3.166	1232.0
SPFBL3200-F	32	45.25	BLIND	41.50	1.875	28	3.332	1444.0
SPFBL3400-F	34	47.50	BLIND	43.50	1.875	28	3.475	1667.0
SPFBL3600-F	36	50.00	BLIND	46.00	2.125	32	3.671	1923.0
SPFBL3800-F	38	52.25	BLIND	48.00	2.125	32	3.815	2193.0
SPFBL4000-F	40	54.25	BLIND	50.25	2.125	36	3.982	2462.0
SPFBL4200-F	42	57.00	BLIND	52.75	2.125	36	4.171	2863.0
SPFBL4400-F	44	59.25	BLIND	55.00	2.125	36	4.338	3230.0
SPFBL4600-F	46	61.50	BLIND	57.25	2.125	40	4.505	3608.0
SPFBL4800-F	48	65.00	BLIND	60.75	2.125	40	4.781	4300.0

Notes:

a. All Stainless Steel flanges available in Dual Grade 304/304L or 316/316L. Material conforms to the requirements of AWWA C228 specifications. Other material is available upon request.

b. Meets ANSI class 300 pattern.

Pressure Ratings: 300psi at atmospheric temperature.

ALL DIMENSIONS ARE IN INCHES UNLESS OTHERWISE STATED.

Light Weight Flanges (1/2" & 5/8" Thick)

Domestic & Import

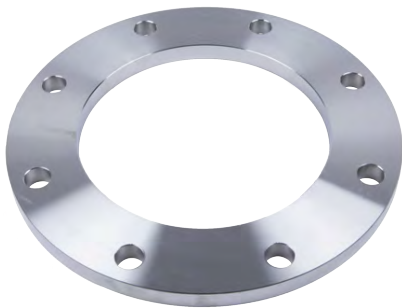

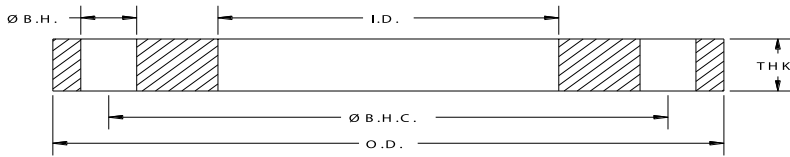

1/2" Thick Steel Slip-on Flanges

API Part Number	Size	O.D.	I.D.	Ø B.H.C.	Ø B.H.	# B.H.	THK	Weight Lbs
PFH0100	1	4.25	1.36	3.13	0.630	4	0.500	1.8
PFH0200	2	6.00	2.44	4.75	0.750	4	0.500	3.1
PFH0250	2.5	7.00	2.94	5.50	0.750	4	0.500	4.2
PFH0300	3	7.50	3.57	6.00	0.750	4	0.500	4.7
PFH0350	3.5	8.50	4.07	7.00	0.750	8	0.500	5.5
PFH0400	4	9.00	4.57	7.50	0.750	8	0.500	6.4
PFH0500	5	10.00	5.66	8.50	0.875	8	0.500	7.2
PFH0600	6	11.00	6.72	9.50	0.875	8	0.500	8.4
PFH0800	8	13.50	8.72	11.75	0.875	8	0.500	11.4
PFH1000	10	16.00	10.88	14.25	1.000	12	0.500	14.6
PFH1200	12	19.00	12.88	17.00	1.000	12	0.500	21.6
PFH1400	14	21.00	14.19	18.75	1.125	12	0.500	25.0
PFH1600	16	23.50	16.19	21.25	1.125	16	0.500	30.0
PFH1800	18	25.00	18.19	22.75	1.250	16	0.500	30.0
PFH2000	20	27.50	20.19	25.00	1.250	20	0.500	36.0
PFH2200	22	29.50	22.19	27.25	1.375	20	0.500	40.0
PFH2400	24	32.00	24.19	29.50	1.375	20	0.500	45.0
PFH2600	26	34.25	26.19	31.75	1.375	24	0.500	48.0
PFH2800	28	36.50	28.19	34.00	1.375	28	0.500	54.0
PFH3000	30	38.75	30.19	36.00	1.375	28	0.500	61.0
PFH3200	32	41.75	32.19	38.50	1.625	28	0.500	74.0
PFH3400	34	43.75	34.19	40.50	1.625	32	0.500	80.0
PFH3600	36	46.00	36.19	42.75	1.625	32	0.500	83.0
PFH3800	38	48.75	38.19	45.25	1.625	32	0.500	93.0
PFH4000	40	50.75	40.19	47.25	1.625	36	0.500	96.0
PFH4200	42	53.00	42.19	49.50	1.625	36	0.500	107.0
PFH4400	44	55.25	44.19	51.75	1.625	40	0.500	111.0
PFH4600	46	57.25	46.19	53.75	1.625	40	0.500	115.0
PFH4800	48	59.50	48.19	56.00	1.625	44	0.500	122.0

Notes:

- a. Flange material is steel (to AWWA C207 specifications). Specific grades of steel for structural or critical applications are available upon request.
- b. Meets ANSI Class 150 pattern

ALL DIMENSIONS ARE IN INCHES UNLESS OTHERWISE STATED.

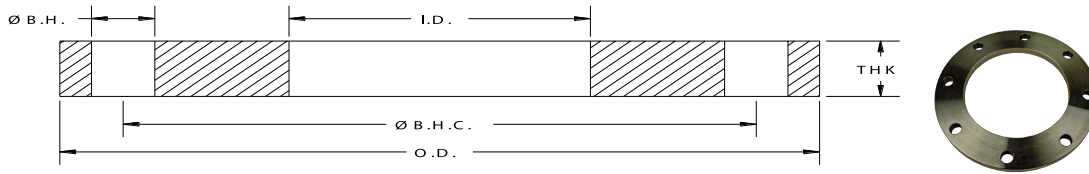

1/2" Thick Reducing Steel Flanges

API Part Number	Size	O.D.	I.D.	Ø B.H.C	Ø B.H.	# B.H	THK	Weight lbs
PFHR0300-206	3 x 2	7.50	2.06	6.00	0.750	4	0.500	5.5
PFHR0400-306	4 x 3	9.00	3.06	7.50	0.750	8	0.500	8.0
PFHR0400-357	4 x 3	9.00	3.57	7.50	0.750	8	0.500	7.2
PFHR0500-306	5 x 3	10.00	3.06	8.50	0.875	8	0.500	9.5
PFHR0500-357	5 x 3	10.00	3.57	8.50	0.850	8	0.500	9.3
PFHR0500-406	5 x 4	10.00	4.06	8.50	0.875	8	0.500	8.8
PFHR0500-457	5 x 4	10.00	4.57	8.50	0.875	8	0.500	8.2
PFHR0600-406	6 x 4	11.00	4.06	9.50	0.875	8	0.500	12.0
PFHR0600-457	6 x 4	11.00	4.57	9.50	0.875	8	0.500	11.4
PFHR0600-506	6 x 5	11.00	5.06	9.50	0.875	8	0.500	10.8
PFHR0600-563	6 x 5	11.00	5.63	9.50	0.875	8	0.500	9.6
PFHR0800-406	8 x 4	13.50	4.06	11.75	0.875	8	0.500	17.7
PFHR0800-506	8 x 5	13.50	5.06	11.75	0.875	8	0.500	16.8
PFHR0800-563	8 x 5	13.50	5.63	11.75	0.875	8	0.500	16.1
PFHR0800-606	8 x 6	13.50	6.06	11.75	0.875	8	0.500	15.6
PFHR0800-672	8 x 6	13.50	6.72	11.75	0.875	8	0.500	14.7
PFHR1000-606	10 x 6	16.00	6.06	14.25	1.000	12	0.500	23.4
PFHR1000-672	10 x 6	16.00	6.72	14.25	1.000	12	0.500	26.0
PFHR1000-806	10 x 8	16.00	8.06	14.25	1.000	12	0.500	20.0
PFHR1000-872	10 x 8	16.00	8.72	14.25	1.000	12	0.500	19.3
PFHR1200-806	12 x 8	19.00	8.06	17.00	1.000	12	0.500	32.0
PFHR1200-1006	12 x 10	19.00	10.06	17.00	1.000	12	0.500	28.5
PFHR1200-1075	12 x 10	19.00	10.75	17.00	1.000	12	0.500	27.0
PFHR1200-1088	12 x 10	19.00	10.88	17.00	1.000	12	0.500	26.0
PFHR1400-806	14 x 8	21.00	8.06	18.75	1.125	12	0.500	40.1
PFHR1400-1006	14 x 10	21.00	10.06	18.75	1.125	12	0.500	36.1
PFHR1400-1206	14 x 12	21.00	12.06	18.75	1.125	12	0.500	32.0
PFHR1600-806	16 x 8	23.50	8.06	21.25	1.125	16	0.500	52.5
PFHR1600-1006	16 x 10	23.50	10.06	21.25	1.125	16	0.500	34.0
PFHR1600-1206	16 x 12	23.50	12.06	21.25	1.125	16	0.500	41.0
PFHR1600-1406	16 x 14	23.50	14.06	21.25	1.125	16	0.500	40.0
PFHR1800-1406	18 x 14	25.00	14.06	22.75	1.250	16	0.500	44.9
PFHR2000-1206	20 x 12	27.50	14.06	25.00	1.250	20	0.500	48.0
PFHR2200-2019	20x 22	29.50	20.19	27.25	1.380	20	0.500	48.5

Notes:

- a. Flange material is steel (to AWWA C207 specifications). Specific grades of steel for structural or critical applications are available upon request.
- b. Meets ANSI Class 150 pattern

ALL DIMENSIONS ARE IN INCHES UNLESS OTHERWISE STATED.

1/2" Thick Steel Slip-on Flanges for O.D. Tubing

API Part Number	Size	O.D.	I.D.	Ø B.H.C.	Ø B.H.	# B.H.	THK	Weight Lbs
PFH0200-16	2	6.00	2.06	4.75	0.750	4	0.500	3.5
PFH0250-16	2.5	7.00	2.56	5.50	0.750	4	0.500	4.5
PFH0300-16	3	7.50	3.06	6.00	0.750	4	0.500	5.3
PFH0350-16	3.5	8.50	3.56	7.00	0.750	8	0.500	6.0
PFH0400-16	4	9.00	4.06	7.50	0.750	8	0.500	6.9
PFH0500-16	5	10.00	5.06	8.50	0.875	8	0.500	8.0
PFH0600-16	6	11.00	6.09	9.50	0.875	8	0.500	9.0
PFH0800-16	8	13.50	8.09	11.75	0.875	8	0.500	12.6
PFH1000-16	10	16.00	10.12	14.25	1.000	12	0.500	16.3
PFH1200-16	12	19.00	12.12	17.00	1.000	12	0.500	22.5

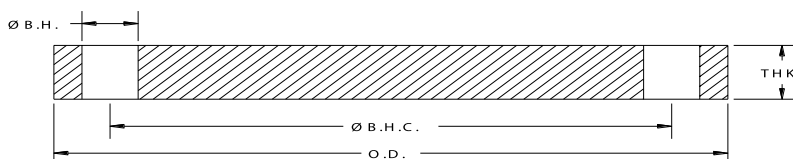

1/2" Thick Steel Blind Flanges

API Part Number	Size	O.D.	I.D.	Ø B.H.C.	Ø B.H.	# B.H.	THK	Weight Lbs
PFBH0200	2	6.00	BLIND	4.75	0.750	4	0.500	4.0
PFBH0250	2.5	7.00	BLIND	5.50	0.750	4	0.500	5.5
PFBH0300	3	7.50	BLIND	6.00	0.750	4	0.500	6.5
PFBH0350	3.5	8.50	BLIND	7.00	0.750	8	0.500	7.5
PFBH0400	4	9.00	BLIND	7.50	0.750	8	0.500	9.0
PFBH0500	5	10.00	BLIND	8.50	0.875	8	0.500	11.5
PFBH0600	6	11.00	BLIND	9.50	0.875	8	0.500	13.5
PFBH0800	8	13.50	BLIND	11.75	0.875	8	0.500	21.0
PFBH1000	10	16.00	BLIND	14.25	1.000	12	0.500	27.8
PFBH1200	12	19.00	BLIND	17.00	1.000	12	0.500	39.7
PFBH1400	14	21.00	BLIND	18.75	1.125	12	0.500	51.5
PFBH1600	16	23.50	BLIND	21.25	1.125	16	0.500	60.0
PFBH1800	18	25.00	BLIND	22.75	1.250	16	0.500	70.0
PFBH2000	20	27.50	BLIND	25.00	1.250	20	0.500	90.0
PFBH2200	22	29.50	BLIND	27.25	1.375	20	0.500	93.0
PFBH2400	24	32.00	BLIND	29.50	1.375	20	0.500	112.0
PFBH2600	26	34.25	BLIND	31.75	1.375	24	0.500	125.0
PFBH2800	28	36.50	BLIND	34.00	1.375	28	0.500	143.0
PFBH3000	30	38.75	BLIND	36.00	1.375	28	0.500	161.0
PFBH3200	32	41.75	BLIND	38.50	1.625	28	0.500	185.0
PFBH3400	34	43.75	BLIND	40.50	1.625	32	0.500	204.0
PFBH3600	36	46.00	BLIND	42.75	1.625	32	0.500	225.0

Notes:

- Flange material is steel (to AWWA C207 specifications). Specific grades of steel for structural or critical applications are available upon request.
- Meets ANSI class 150 pattern.

ALL DIMENSIONS ARE IN INCHES UNLESS OTHERWISE STATED.

DC# 0125

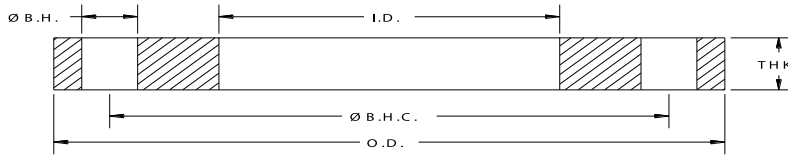

1/2" Thick Stainless Steel Slip-on Flanges for Pipe

API Part Number	Size	O.D.	I.D.	Ø B.H.C	Ø B.H.	# B.H	THK	Weight lbs
SPFH0050	0.5	3.50	0.88	2.38	0.630	4	0.500	1.0
SPFH0075	0.75	3.88	1.09	2.75	0.630	4	0.500	1.3
SPFH0100	1	4.25	1.36	3.13	0.630	4	0.500	1.7
SPFH0125	1.25	4.63	1.70	3.50	0.630	4	0.500	2.3
SPFH0150	1.5	5.00	1.95	3.88	0.630	4	0.500	2.5
SPFH0200	2	6.00	2.44	4.75	0.750	4	0.500	3.0
SPFH0250	2.5	7.00	2.94	5.50	0.750	4	0.500	4.0
SPFH0300	3	7.50	3.57	6.00	0.750	4	0.500	4.7
SPFH0350	3.5	8.50	4.07	7.00	0.750	8	0.500	5.5
SPFH0400	4	9.00	4.57	7.50	0.750	8	0.500	6.4
SPFH0500	5	10.00	5.66	8.50	0.875	8	0.500	7.2
SPFH0600	6	11.00	6.72	9.50	0.875	8	0.500	8.4
SPFH0800	8	13.50	8.72	11.75	0.875	8	0.500	11.4
SPFH1000	10	16.00	10.88	14.25	1.000	12	0.500	14.6
SPFH1200	12	19.00	12.88	17.00	1.000	12	0.500	21.6
SPFH1400	14	21.00	14.19	18.75	1.125	12	0.500	26.5
SPFH1600	16	23.50	16.19	21.25	1.125	16	0.500	31.0
SPFH1800	18	25.00	18.19	22.75	1.250	16	0.500	32.0
SPFH2000	20	27.50	20.19	25.00	1.250	20	0.500	37.5
SPFH2200	22	29.50	22.19	27.25	1.375	20	0.500	38.5
SPFH2400	24	32.00	24.19	29.50	1.375	20	0.500	49.0
SPFH2600	26	34.25	26.19	31.75	1.375	24	0.500	52.0
SPFH2800	28	36.50	28.19	34.00	1.375	28	0.500	54.0
SPFH3000	30	38.75	30.19	36.00	1.375	28	0.500	65.0
SPFH3200	32	41.75	32.19	38.50	1.625	28	0.500	70.0
SPFH3400	34	43.75	34.19	40.50	1.625	32	0.500	74.0
SPFH3600	36	46.00	36.19	42.75	1.625	32	0.500	81.0
SPFH3800	38	48.75	38.19	45.25	1.625	32	0.500	93.0
SPFH4000	40	50.75	40.19	47.25	1.625	36	0.500	97.0
SPFH4200	42	53.00	42.19	49.50	1.625	36	0.500	104.0
SPFH4400	44	55.25	44.19	51.75	1.625	40	0.500	111.0
SPFH4600	46	57.25	46.19	53.75	1.625	40	0.500	118.0
SPFH4800	48	59.50	48.19	56.00	1.625	44	0.500	124.0

1/2" Thick Stainless Steel Slip-on Flanges for O.D. Tubing

API Part Number	Size	O.D.	I.D.	Ø B.H.C	Ø B.H.	# B.H	THK	Weight lbs
SPFH0050-16	0.5	3.50	0.56	2.38	0.630	4	0.500	1.1
SPFH0075-16	0.75	3.88	0.81	2.75	0.630	4	0.500	1.5
SPFH0100-16	1	4.25	1.06	3.13	0.630	4	0.500	2.0
SPFH0125-16	1.25	4.63	1.31	3.50	0.630	4	0.500	2.6
SPFH0150-16	1.5	5.00	1.56	3.88	0.630	4	0.500	2.8
SPFH0200-16	2	6.00	2.06	4.75	0.750	4	0.500	3.5
SPFH0250-16	2.5	7.00	2.56	5.50	0.750	4	0.500	4.5
SPFH0300-16	3	7.50	3.06	6.00	0.750	4	0.500	5.3
SPFH0350-16	3.5	8.50	3.56	7.00	0.750	8	0.500	6.0
SPFH0400-16	4	9.00	4.06	7.50	0.750	8	0.500	6.9
SPFH0500-16	5	10.00	5.06	8.50	0.875	8	0.500	8.0
SPFH0600-16	6	11.00	6.09	9.50	0.875	8	0.500	9.0
SPFH0800-16	8	13.50	8.09	11.75	0.875	8	0.500	12.6
SPFH1000-16	10	16.00	10.12	14.25	1.000	12	0.500	16.3
SPFH1200-16	12	19.00	12.12	17.00	1.000	12	0.500	22.5

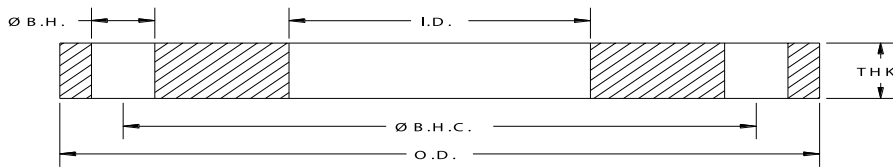

1/2" Thick Reducing Stainless Steel Flanges

API Part Number	Size	O.D.	I.D.	Ø B.H.C	Ø B.H	# B.H	THK	Weight lbs
SPFHR0500-406	5 x 4	10.00	4.06	8.50	0.88	8	0.500	9.0
SPFHR0600-406	6 x 4	11.00	4.06	9.50	0.88	8	0.500	11.0
SPFHR0600-506	6 x 5	11.00	5.06	9.50	0.88	8	0.500	10.5
SPFHR0800-506	8 x 5	13.50	5.06	11.75	0.88	8	0.500	18.0
SPFHR0800-606	8 x 6	13.50	6.06	11.75	0.88	8	0.500	16.5
SPFHR0800-672	8 x 6	13.50	6.72	11.75	0.88	8	0.500	15.0
SPFHR1000-606	10 x 6	16.00	6.06	14.25	1.00	12	0.500	18.0
SPFHR1000-806	10 x 8	16.00	8.06	14.25	1.00	12	0.500	20.0
SPFHR1200-1006	12 x 10	19.00	10.06	17.00	1.00	12	0.500	31.0
SPFHR1200-806	12 x 8	19.00	8.06	17.00	1.00	12	0.500	34.0
SPFHR1400-1288	14 x 12	21.00	12.88	18.75	1.13	12	0.500	28.0

Notes:

- a. All Stainless Steel flanges available in Dual Grade 304/304L or 316/316L.
- b. Meets ANSI Class 150 pattern

ALL DIMENSIONS ARE IN INCHES UNLESS OTHERWISE STATED.

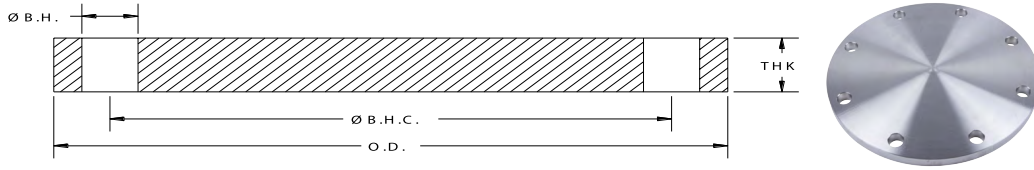

1/2" Thick Stainless Steel Blind Flanges

API Part Number	Size	O.D.	I.D.	Ø B.H.C	Ø B.H.	# B.H	THK	Weight lbs
SPFBH0200	2	6.00	BLIND	4.75	0.750	4	0.500	4.0
SPFBH0250	2.5	7.00	BLIND	5.50	0.750	4	0.500	5.5
SPFBH0300	3	7.50	BLIND	6.00	0.750	4	0.500	6.2
SPFBH0350	3.5	8.50	BLIND	7.00	0.750	8	0.500	7.5
SPFBH0400	4	9.00	BLIND	7.50	0.750	8	0.500	9.1
SPFBH0500	5	10.00	BLIND	8.50	0.875	8	0.500	11.0
SPFBH0600	6	11.00	BLIND	9.50	0.875	8	0.500	14.3
SPFBH0800	8	13.50	BLIND	11.75	0.875	8	0.500	20.0
SPFBH1000	10	16.00	BLIND	14.25	1.000	12	0.500	27.0
SPFBH1200	12	19.00	BLIND	17.00	1.000	12	0.500	41.0
SPFBH1400	14	21.00	BLIND	18.75	1.125	12	0.500	51.2
SPFBH1600	16	23.50	BLIND	21.25	1.125	16	0.500	60.0
SPFBH1800	18	25.00	BLIND	22.75	1.250	16	0.500	70.3
SPFBH2000	20	27.50	BLIND	25.00	1.250	20	0.500	90.0
SPFBH2200	22	29.50	BLIND	27.25	1.375	20	0.500	93.0
SPFBH2400	24	32.00	BLIND	29.50	1.375	20	0.500	109.0
SPFBH2600	26	34.25	BLIND	31.75	1.375	24	0.500	126.0
SPFBH2800	28	36.50	BLIND	34.00	1.375	28	0.500	142.3
SPFBH3000	30	38.75	BLIND	36.00	1.375	28	0.500	161.1
SPFBH3200	32	41.75	BLIND	38.50	1.625	28	0.500	185.2
SPFBH3400	34	43.75	BLIND	40.50	1.625	32	0.500	203.0
SPFBH3600	36	46.00	BLIND	42.75	1.625	32	0.500	225.0

Notes:

- a. All Stainless Steel flanges available in Dual Grade 304/304L or 316/316L.
- b. Meets ANSI class 150 pattern.

ALL DIMENSIONS ARE IN INCHES UNLESS OTHERWISE STATED.

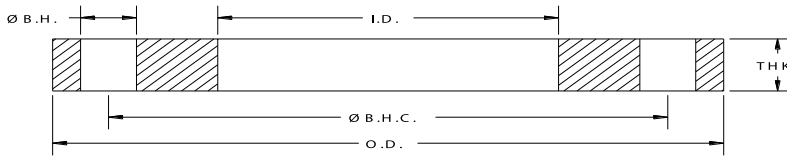

5/8" Thick Class 150IPS Slip-on Flanges

API Part Number	Size	O.D.	I.D.	Ø B.H.C.	Ø B.H.	# B.H.	THK	Weight Lbs
PF2200-063	22	29.50	22.19	27.25	1.38	20	0.63	48
PF2400-063	24	32.00	24.19	29.50	1.38	20	0.63	55
PF2600-063	26	34.25	26.19	31.75	1.38	24	0.63	63
PF2800-063	28	36.50	28.19	34.00	1.38	28	0.63	65
PF3000-063	30	38.75	30.19	36.00	1.38	28	0.63	77
PF3200-063	32	41.75	32.19	38.50	1.63	28	0.63	90
PF3400-063	34	43.75	34.19	40.50	1.63	32	0.63	93
PF3600-063	36	46.00	36.19	42.75	1.63	32	0.63	100
PF3800-063	38	48.75	38.19	45.25	1.63	32	0.63	117
PF4000-063	40	50.75	40.19	47.25	1.63	36	0.63	119
PF4200-063	42	53.00	42.19	49.50	1.63	36	0.63	130

Notes:

- a. Flange material is steel (to AWWA C207 specifications). Specific grades of steel for structural or critical applications are available upon request.
- b. Meets ANSI class 150 pattern.

ALL DIMENSIONS ARE IN INCHES UNLESS OTHERWISE STATED.

Miscellaneous Plate Flanges

Domestic & Import

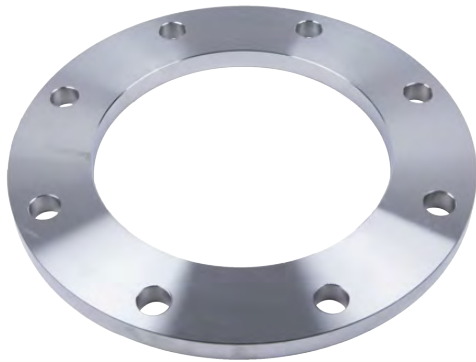

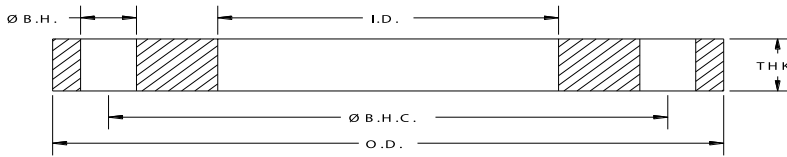

Class 150 Steel Slip-on Plate Flanges

API Part Number	Size	O.D.	I.D.	Ø B.H.C.	Ø B.H.	# B.H.	THK	Weight Lbs
PF0050	0.5	3.50	0.88	2.38	0.630	4	0.500	1.2
PF0075	0.75	3.88	1.09	2.75	0.630	4	0.500	1.5
PF0100	1	4.25	1.36	3.13	0.630	4	0.500	1.8
PF0125	1.25	4.63	1.70	3.50	0.630	4	0.500	1.9
PF0150	1.5	5.00	1.95	3.88	0.630	4	0.630	2.9
PF0200	2	6.00	2.44	4.75	0.750	4	0.630	4.1
PF0250	2.5	7.00	2.94	5.50	0.750	4	0.630	5.4
PF0300	3	7.50	3.57	6.00	0.750	4	0.630	5.9
PF0400	4	9.00	4.57	7.50	0.750	8	0.630	8.1
PF0500	5	10.00	5.66	8.50	0.875	8	0.750	10.4
PF0600	6	11.00	6.72	9.50	0.875	8	0.750	11.4
PF0800	8	13.50	8.72	11.75	0.875	8	1.000	22.0
PF1000	10	16.00	10.88	14.25	1.000	12	1.000	28.5
PF1200	12	19.00	12.88	17.00	1.000	12	1.000	41.5

Notes:

- a. Flange material is steel (to AWWA C207-13 specifications). Specific grades of steel for structural or critical applications are available upon request.
- b. Meets ANSI class 150 pattern.

ALL DIMENSIONS ARE IN INCHES UNLESS OTHERWISE STATED.

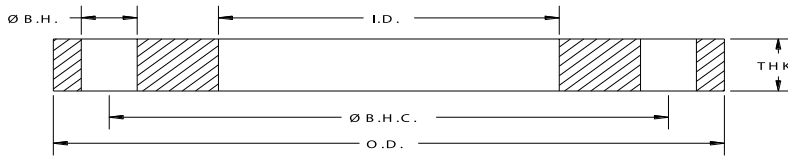

Class 150 Stainless Steel Slip-on Plate Flanges

API Part Number	Size	O.D.	I.D.	Ø B.H.C	Ø B.H.	# B.H	THK	Weight lbs
SPF0050	0.5	3.50	0.88	2.38	0.630	4	0.500	1.2
SPF0075	0.75	3.88	1.09	2.75	0.630	4	0.500	1.5
SPF0100	1	4.25	1.36	3.13	0.630	4	0.500	1.8
SPF0125	1.25	4.63	1.70	3.50	0.630	4	0.500	1.9
SPF0150	1.5	5.00	1.95	3.88	0.630	4	0.630	2.9
SPF0200	2	6.00	2.44	4.75	0.750	4	0.630	4.1
SPF0250	2.5	7.00	2.94	5.50	0.750	4	0.630	5.4
SPF0300	3	7.50	3.57	6.00	0.750	4	0.630	5.9
SPF0400	4	9.00	4.57	7.50	0.750	8	0.630	8.1
SPF0500	5	10.00	5.66	8.50	0.875	8	0.750	10.4
SPF0600	6	11.00	6.72	9.50	0.875	8	0.750	11.4
SPF0800	8	13.50	8.72	11.75	0.875	8	1.000	22.0
SPF1000	10	16.00	10.88	14.25	1.000	12	1.000	28.5
SPF1200	12	19.00	12.88	17.00	1.000	12	1.000	41.5

Notes:

- a. All Stainless Steel flanges available in Dual Grade 304/304L or 316/316L.
- b. Meets ANSI class 150 pattern.

ALL DIMENSIONS ARE IN INCHES UNLESS OTHERWISE STATED.

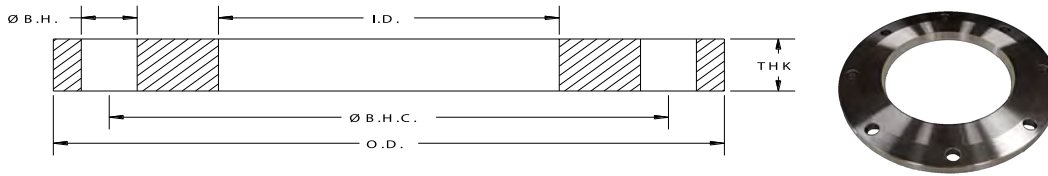

Butterfly Valve Adapter 4020 Flange

API Part Number	Size	O.D.	Ø Serrations	Ø B.H.C	I.D.	# B.H.	Ø B.H	THK
402032000	2	5.063	3.375	4.281	2.032	4	0.406	.469
402031000	3	5.750	4.250	4.906	3.032	6	0.438	.469
402028000	4	8.000	6.250	7.031	4.032	6	0.563	.469
402029000	5	8.500	7.000	7.563	5.032	6	0.563	.469
402030000	6	10.250	8.500	9.156	6.063	8	0.563	.469
402027000	8	13.500	11.750	11.750	8.032	8	0.750	.630
402036000	10	16.000	14.250	14.250	10.032	12	0.688	.630
402033000	12	19.000	17.000	17.000	12.000	12	1.000	.630

Notes:

- a. Material ASTM A105 Mild Steel

ALL DIMENSIONS ARE IN INCHES UNLESS OTHERWISE STATED.

ANSI/ASME B16.5

Forged Flanges

Domestic & Import



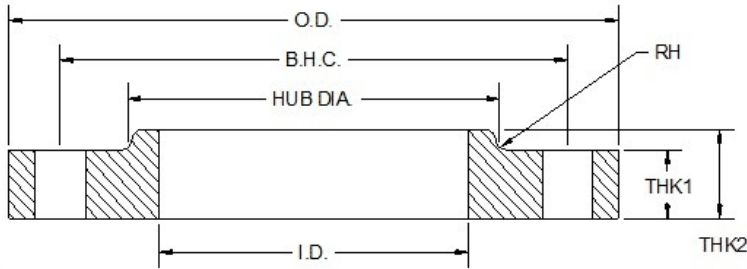

ANSI Class 150 Forged Steel Flat Face Slip-on Flanges

API Part Number	Size	O.D.	I.D.	Ø B.H.C.	Ø B.H.	# B.H.	THK1	THK2	H.D.	RH (RAD)	Weight Lbs
FFS0200	2	6.00	2.44	4.75	0.75	4	0.75	1.00	3.06	0.188	5.0
FFS0250	2.5	7.00	2.94	5.50	0.75	4	0.81	1.06	3.56	0.188	7.0
FFS0300	3	7.50	3.57	6.00	0.75	4	0.88	1.12	4.25	0.188	8.0
FFS0400	4	9.00	4.57	7.50	0.75	8	0.88	1.25	5.31	0.188	13.0
FFS0600	6	11.00	6.72	9.50	0.88	8	0.94	1.50	7.56	0.250	19.0
FFS0800	8	13.50	8.72	11.75	0.88	8	1.06	1.69	9.69	0.250	30.0
FFS1000	10	16.00	10.88	14.25	1.00	12	1.12	1.88	12.00	0.250	43.0
FFS1200	12	19.00	12.88	17.00	1.00	12	1.19	2.12	14.38	0.313	58.0
FFS1400	14	21.00	14.14	18.75	1.12	12	1.31	2.19	15.75	0.313	90.0
FFS1600	16	23.50	16.16	21.25	1.12	16	1.38	2.44	18.00	0.313	95.0
FFS1800	18	25.00	18.18	22.75	1.25	16	1.50	2.62	19.88	0.313	130.0
FFS2000	20	27.50	20.20	25.00	1.25	20	1.65	2.81	22.00	0.313	165.0
FFS2200	22	29.50	22.22	27.25	1.38	20	1.75	3.07	24.25	0.313	185.0
FFS2400	24	32.00	24.19	29.50	1.38	20	1.88	3.25	26.13	0.313	220.0

Notes:

- a. Material meets ASTM A105 Mild Steel requirements
- b. Fully Machined
- c. Dimensions and Tolerances per ANSI B16.5
- d. Flanges are painted black
- e. Bolt pattern per ANSI Class 150.

ALL DIMENSIONS ARE IN INCHES UNLESS OTHERWISE STATED.

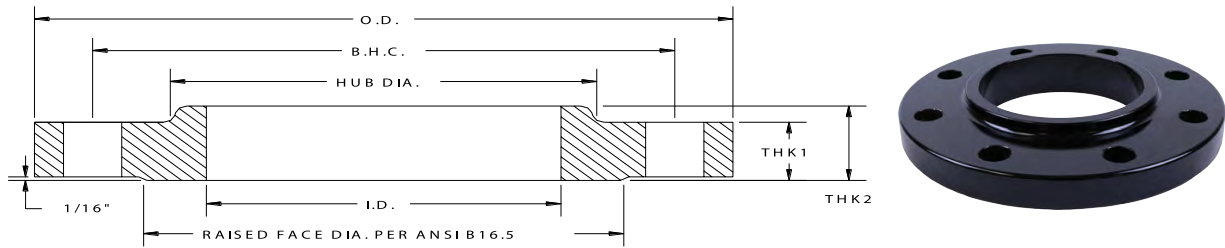

ANSI Class 150 Forged Steel Raised Face Slip-on Flanges

API Part Number	Size	O.D.	I.D.	Ø B.H.C.	Ø B.H.	# B.H.	THK1	THK2	H.D.	RF DIA	RH (RAD)	Weight Lbs
RFS0050	0.5	3.50	0.88	2.38	0.630	4	0.440	0.630	1.190	1.375	0.188	1.2
RFS0075	0.75	3.88	1.09	2.75	0.630	4	0.500	0.630	1.500	1.688	0.188	1.6
RFS0100	1	4.25	1.36	3.13	0.630	4	0.563	0.690	1.940	2.000	0.188	2.0
RFS0125	1.25	4.63	1.70	3.50	0.630	4	0.630	0.813	2.313	2.500	0.188	3.0
RFS0150	1.5	5.00	1.95	3.88	0.630	4	0.690	0.880	2.563	2.875	0.188	3.0
RFS0200	2	6.00	2.44	4.75	0.750	4	0.750	1.000	3.063	3.625	0.188	5.0
RFS0250	2.5	7.00	2.94	5.50	0.750	4	0.880	1.130	3.563	4.125	0.188	8.0
RFS0300	3	7.50	3.57	6.00	0.750	4	0.940	1.190	4.250	5.000	0.188	9.0
RFS0350	3.5	8.50	4.07	7.00	0.750	8	0.940	1.250	4.810	5.500	0.188	10.5
RFS0400	4	9.00	4.57	7.50	0.750	8	0.940	1.313	5.312	6.188	0.188	13.0
RFS0500	5	10.00	5.66	8.50	0.875	8	0.940	1.440	6.440	7.313	0.188	15.0
RFS0600	6	11.00	6.72	9.50	0.875	8	1.000	1.563	7.563	8.500	0.250	17.0
RFS0800	8	13.50	8.72	11.75	0.875	8	1.130	1.750	9.690	10.625	0.250	28.0
RFS1000	10	16.00	10.88	14.25	1.000	12	1.190	1.940	12.000	12.750	0.250	40.0
RFS1200	12	19.00	12.88	17.00	1.000	12	1.250	2.190	14.380	15.000	0.313	61.0
RFS1400	14	21.00	14.14	18.75	1.125	12	1.380	2.250	15.750	16.250	0.313	83.0
RFS1600	16	23.50	16.16	21.25	1.125	16	1.440	2.500	18.000	18.500	0.313	106.0
RFS1800	18	25.00	18.18	22.75	1.250	16	1.563	2.690	19.880	21.000	0.313	109.0
RFS2000	20	27.50	20.20	25.00	1.250	20	1.690	2.880	22.000	23.000	0.313	148.0
RFS2200	22	29.50	22.22	27.25	1.375	20	1.840	3.130	24.250	25.250	0.313	185.0
RFS2400	24	32.00	24.25	29.50	1.375	20	1.880	3.250	26.130	27.250	0.313	204.0

Notes:

- a. Dimensions and Tolerances per ANSI B16.5.
- b. Flanges are painted black.
- c. ASTM A-105.
- d. Meets ANSI class 150 pattern.

ALL DIMENSIONS ARE IN INCHES UNLESS OTHERWISE STATED.

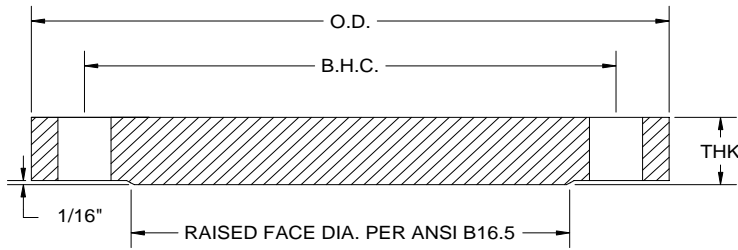

ANSI Class 150 Forged Steel Raised Face Blind Flanges

API Part Number	Size	O.D.	I.D.	∅ B.H.C.	∅ B.H.	# B.H.	THK1	RF DIA	Weight Lb
RFB0050	0.5	3.50	BLIND	2.38	0.630	4	0.440	1.375	1.0
RFB0075	0.75	3.88	BLIND	2.75	0.630	4	0.500	1.688	1.0
RFB0100	1	4.25	BLIND	3.13	0.630	4	0.563	2.000	2.0
RFB0125	1.25	4.63	BLIND	3.50	0.630	4	0.630	2.500	2.9
RFB0150	1.5	5.00	BLIND	3.88	0.630	4	0.690	2.875	3.5
RFB0200	2	6.00	BLIND	4.75	0.750	4	0.750	3.625	5.0
RFB0250	2.5	7.00	BLIND	5.50	0.750	4	0.880	4.125	9.0
RFB0300	3	7.50	BLIND	6.00	0.750	4	0.940	5.000	9.0
RFB0350	3.5	8.50	BLIND	7.00	0.750	8	0.940	5.500	13.0
RFB0400	4	9.00	BLIND	7.50	0.750	8	0.940	6.188	17.0
RFB0500	5	10.00	BLIND	8.50	0.875	8	0.940	7.313	19.7
RFB0600	6	11.00	BLIND	9.50	0.875	8	1.000	8.500	27.0
RFB0800	8	13.50	BLIND	11.75	0.875	8	1.130	10.625	43.5
RFB1000	10	16.00	BLIND	14.25	1.000	12	1.190	12.750	65.5
RFB1200	12	19.00	BLIND	17.00	1.000	12	1.250	15.000	123.0
RFB1400	14	21.00	BLIND	18.75	1.125	12	1.380	16.250	133.3
RFB1600	16	23.50	BLIND	21.25	1.125	16	1.440	18.500	180.0
RFB1800	18	25.00	BLIND	22.75	1.250	16	1.563	21.000	220.0
RFB2000	20	27.50	BLIND	25.00	1.250	20	1.690	23.000	284.0
RFB2200	22	29.50	BLIND	27.25	1.375	20	1.840	25.250	360.0
RFB2400	24	32.00	BLIND	29.50	1.375	20	1.880	27.250	445.0

Notes:

- a. Dimensions and Tolerances per ANSI B16.5.
- b. Flanges are painted black.
- c. ASTM A-105.
- d. Meets ANSI class 150 pattern.

ALL DIMENSIONS ARE IN INCHES UNLESS OTHERWISE STATED.

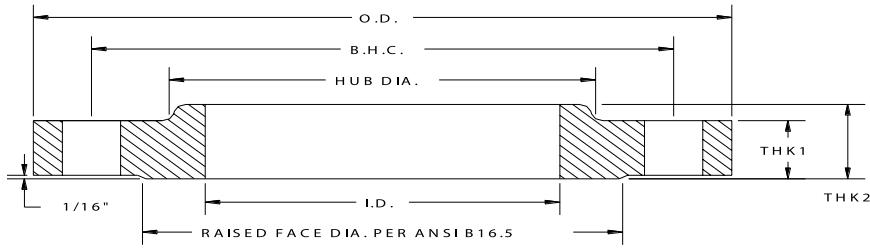

ANSI Class 300 Forged Steel Raised Face Slip-on Flanges

API Part Number	Size	O.D.	I.D.	Ø B.H.C	Ø B.H.	# B.H.	THK1	THK2	H.D.	RF DIA	RH (RAD)	Weight lbc
RFS0050-30	0.5	3.75	0.88	2.63	0.750	4	0.563	0.880	1.500	1.375	0.188	2.0
RFS0075-30	0.75	4.63	1.09	3.25	0.750	4	0.625	1.000	1.875	1.688	0.188	2.4
RFS0100-30	1	4.88	1.36	3.50	0.750	4	0.688	1.063	2.125	2.000	0.188	3.0
RFS0125-30	1.25	5.25	1.70	3.88	0.750	4	0.750	1.063	2.500	2.500	0.188	4.5
RFS0150-30	1.5	6.13	1.95	4.50	0.875	4	0.813	1.188	2.750	2.875	0.188	6.5
RFS0200-30	2	6.50	2.44	5.00	0.750	8	0.875	1.313	3.313	3.625	0.188	7.0
RFS0250-30	2.50	7.50	2.94	5.88	0.875	8	1.000	1.500	3.938	4.125	0.188	10.0
RFS0300-30	3	8.25	3.57	6.63	0.875	8	1.125	1.688	4.625	5.000	0.188	13.0
RFS0350-30	3.5	9.00	3.57	7.25	0.875	8	1.188	1.750	5.250	5.500	0.188	17.0
RFS0400-30	4	10.00	4.57	7.88	0.875	8	1.250	1.875	5.750	6.188	0.188	23.5
RFS0500-30	5	11.00	5.66	9.25	0.875	8	1.375	2.000	7.000	7.313	0.188	29.0
RFS0600-30	6	12.50	6.72	10.63	0.875	12	1.438	2.063	8.125	8.500	0.250	36.0
RFS0800-30	8	15.00	8.72	13.00	1.000	12	1.625	2.438	10.250	10.625	0.250	56.0
RFS1000-30	10	17.50	10.88	15.25	1.125	16	1.875	2.625	12.625	12.750	0.250	77.0
RFS1200-30	12	20.50	12.88	17.75	1.250	16	2.000	2.875	14.750	15.000	0.313	113.0
RFS1400-30	14	23.00	14.14	20.25	1.250	20	2.125	3.000	16.750	16.250	0.313	159.0
RFS1600-30	16	25.50	16.16	22.50	1.375	20	2.250	3.250	19.000	18.500	0.313	210.0
RFS1800-30	18	28.00	18.18	24.75	1.375	24	2.375	3.500	21.000	21.000	0.313	253.0
RFS2000-30	20	30.50	20.20	27.00	1.375	24	2.500	3.750	23.125	23.000	0.313	307.0
RFS2400-30	24	36.00	24.25	32.00	1.625	24	2.750	4.188	27.625	27.250	0.313	490.0

Notes:

- a. Dimensions and Tolerances per ANSI B16.5.
- b. Flanges are painted black.
- c. ASTM A-105.
- d. Meets ANSI class 300 pattern.

ALL DIMENSIONS ARE IN INCHES UNLESS OTHERWISE STATED.

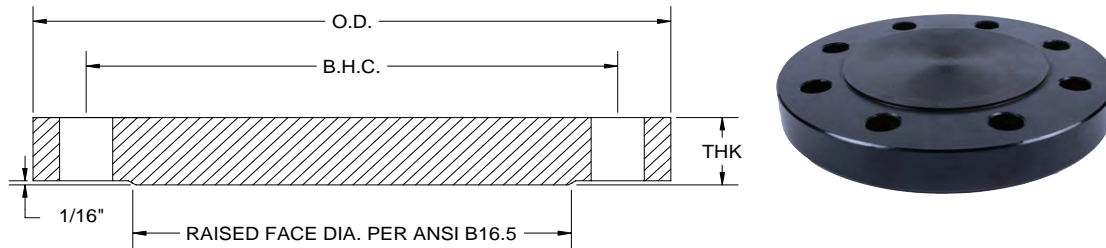

ANSI Class 300 Forged Steel Raised Face Blind Flanges

API Part Number	Size	O.D.	I.D.	∅ B.H.C	∅ B.H.	# B.H	THK	RF DIA	Weight lbs
RFB0050-30	0.5	3.75	BLIND	2.63	0.750	4	0.563	1.375	1.4
RFB0075-30	0.75	4.63	BLIND	3.25	0.750	4	0.625	1.688	2.5
RFB0100-30	1	4.88	BLIND	3.50	0.750	4	0.688	2.000	3.0
RFB0125-30	1.25	5.25	BLIND	3.88	0.750	4	0.750	2.500	4.0
RFB0150-30	1.5	6.13	BLIND	4.50	0.875	4	0.813	2.875	6.0
RFB0200-30	2	6.50	BLIND	5.00	0.750	8	0.875	3.625	8.0
RFB0250-30	2.50	7.50	BLIND	5.88	0.875	8	1.000	4.125	11.0
RFB0300-30	3	8.25	BLIND	6.63	0.875	8	1.125	5.000	15.0
RFB0350-30	3.5	9.00	BLIND	7.25	0.875	8	1.188	5.500	20.0
RFB0400-30	4	10.00	BLIND	7.88	0.875	8	1.250	6.188	25.0
RFB0500-30	5	11.00	BLIND	9.25	0.875	8	1.375	7.313	35.0
RFB0600-30	6	12.50	BLIND	10.63	0.875	12	1.438	8.500	46.0
RFB0800-30	8	15.00	BLIND	13.00	1.000	12	1.625	10.625	75.0
RFB1000-30	10	17.50	BLIND	15.25	1.125	16	1.875	12.750	124.0
RFB1200-30	12	20.50	BLIND	17.75	1.250	16	2.000	15.000	174.0
RFB1400-30	14	23.00	BLIND	20.25	1.250	20	2.125	16.250	246.0
RFB1600-30	16	25.50	BLIND	22.50	1.375	20	2.250	18.500	315.0
RFB1800-30	18	28.00	BLIND	24.75	1.375	24	2.375	21.000	427.0
RFB2000-30	20	30.50	BLIND	27.00	1.375	24	2.500	23.000	515.0
RFB2400-30	24	36.00	BLIND	32.00	1.625	24	2.750	27.250	800.0

Notes:

- a. Dimensions and Tolerances per ANSI B16.5.
- b. Flanges are painted black.
- c. ASTM A-105.
- d. Meets ANSI class 300 pattern.

ALL DIMENSIONS ARE IN INCHES UNLESS OTHERWISE STATED.

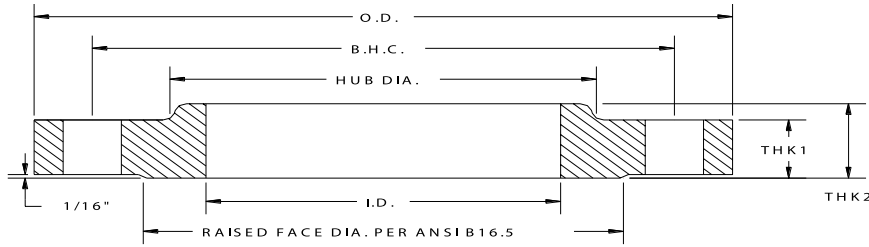

ANSI Class 150 Forged Stainless Steel Raised Face Slip-on Flanges

API Part Number	Size	O.D.	I.D.	Ø B.H.C	Ø B.H.	# B.H	THK1	THK2	H.D.	RF DIA	RH (RAD)	Weight lbs
SRFS0050	0.5	3.50	0.88	2.38	0.630	4	0.440	0.630	1.190	1.375	0.188	1.2
SRFS0075	0.75	3.88	1.09	2.75	0.630	4	0.500	0.630	1.500	1.688	0.188	1.6
SRFS0100	1	4.25	1.36	3.13	0.630	4	0.563	0.690	1.940	2.000	0.188	2.0
SRFS0125	1.25	4.63	1.70	3.50	0.630	4	0.630	0.813	2.313	2.500	0.188	3.0
SRFS0150	1.5	5.00	1.95	3.88	0.630	4	0.690	0.880	2.563	2.875	0.188	3.0
SRFS0200	2	6.00	2.44	4.75	0.750	4	0.750	1.000	3.063	3.625	0.188	5.0
SRFS0250	2.5	7.00	2.94	5.50	0.750	4	0.880	1.130	3.563	4.125	0.188	8.0
SRFS0300	3	7.50	3.57	6.00	0.750	4	0.940	1.190	4.250	5.000	0.188	9.0
SRFS0350	3.5	8.50	4.07	7.00	0.750	8	0.940	1.250	4.810	5.500	0.188	11.0
SRFS0400	4	9.00	4.57	7.50	0.750	8	0.940	1.313	5.312	6.188	0.188	13.0
SRFS0500	5	10.00	5.66	8.50	0.875	8	0.940	1.440	6.440	7.313	0.188	15.0
SRFS0600	6	11.00	6.72	9.50	0.875	8	1.000	1.563	7.563	8.500	0.250	17.0
SRFS0800	8	13.50	8.72	11.75	0.875	8	1.130	1.750	9.690	10.625	0.250	28.0
SRFS1000	10	16.00	10.88	14.25	1.000	12	1.190	1.940	12.000	12.750	0.250	40.0
SRFS1200	12	19.00	12.88	17.00	1.000	12	1.250	2.190	14.380	15.000	0.313	61.0
SRFS1400	14	21.00	14.14	18.75	1.125	12	1.380	2.250	15.750	16.250	0.313	83.0
SRFS1600	16	23.50	16.16	21.25	1.125	16	1.440	2.500	18.000	18.500	0.313	106.0
SRFS1800	18	25.00	18.18	22.75	1.250	16	1.563	2.690	19.880	21.000	0.313	109.0
SRFS2000	20	27.50	20.20	25.00	1.250	20	1.690	2.880	22.000	23.000	0.313	148.0
SRFS2200	22	29.50	22.22	27.25	1.375	20	1.840	3.130	24.250	25.250	0.313	174.0
SRFS2400	24	32.00	24.25	29.50	1.375	20	1.880	3.250	26.130	27.250	0.313	204.0

Notes:

- a. Dimensions and Tolerances per ANSI B16.5.
- b. All Stainless Steel flanges available in Dual Grade 304/304L or 316/316L.
- c. ASTM A182.
- d. Meets ANSI class 150 pattern.

ALL DIMENSIONS ARE IN INCHES UNLESS OTHERWISE STATED.

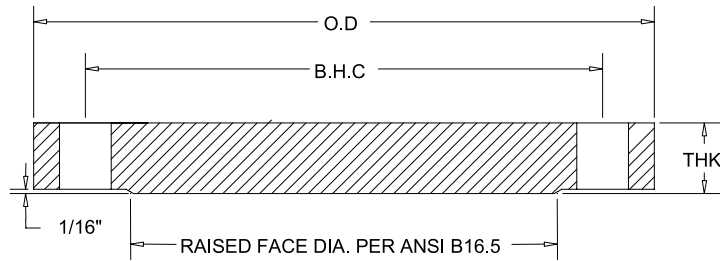

ANSI Class 150 Forged Stainless Steel Raised Face Blind Flanges

API Part Number	Size	O.D.	I.D.	∅ B.H.C	∅ B.H.	# B.H	THK	RF DIA	Weight lbs
SRFB0050	0.5	3.50	BLIND	2.38	0.630	4	0.440	1.375	3.0
SRFB0075	0.75	3.88	BLIND	2.75	0.630	4	0.500	1.688	4.0
SRFB0100	1	4.25	BLIND	3.13	0.630	4	0.563	2.000	4.5
SRFB0125	1.25	4.63	BLIND	3.50	0.630	4	0.630	2.500	5.0
SRFB0150	1.5	5.00	BLIND	3.88	0.630	4	0.690	2.875	5.5
SRFB0200	2	6.00	BLIND	4.75	0.750	4	0.750	3.625	6.0
SRFB0250	2.5	7.00	BLIND	5.50	0.750	4	0.880	4.125	9.0
SRFB0300	3	7.50	BLIND	6.00	0.750	4	0.940	5.000	11.5
SRFB0350	3.5	8.50	BLIND	7.00	0.750	8	0.940	5.500	13.5
SRFB0400	4	9.00	BLIND	7.50	0.750	8	0.940	6.188	15.5
SRFB0500	5	10.00	BLIND	8.50	0.875	8	0.940	7.313	19.5
SRFB0600	6	11.00	BLIND	9.50	0.875	8	1.000	8.500	25.5
SRFB0800	8	13.50	BLIND	11.75	0.875	8	1.130	10.625	44.5
SRFB1000	10	16.00	BLIND	14.25	1.000	12	1.190	12.750	67.0
SRFB1200	12	19.00	BLIND	17.00	1.000	12	1.250	15.000	98.0
SRFB1400	14	21.00	BLIND	18.75	1.125	12	1.380	16.250	134.0
SRFB1600	16	23.50	BLIND	21.25	1.125	16	1.440	18.500	176.0
SRFB1800	18	25.00	BLIND	22.75	1.250	16	1.563	21.000	215.0
SRFB2000	20	27.50	BLIND	25.00	1.250	20	1.690	23.000	286.0
SRFB2200	22	29.50	BLIND	27.25	1.375	20	1.840	25.250	358.0
SRFB2400	24	32.00	BLIND	29.50	1.375	20	1.880	27.250	426.0

Notes:

- a. Dimensions and Tolerances per ANSI B16.5.
- b. All Stainless Steel flanges available in Dual Grade 304/304L or 316/316L.
- c. ASTM A182.
- d. Meets ANSI class 150 pattern.

ALL DIMENSIONS ARE IN INCHES UNLESS OTHERWISE STATED.

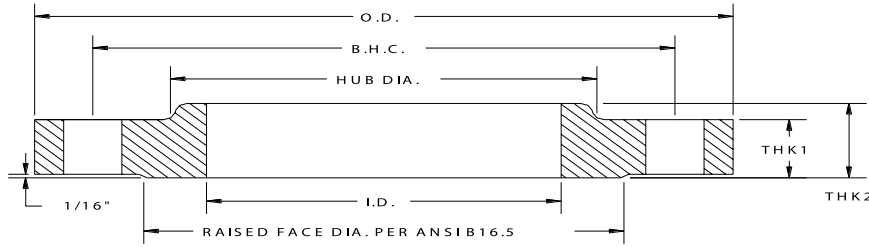

ANSI Class 300 Forged Stainless Steel Raised Face Slip-on Flanges

API Part Number	Size	O.D.	I.D.	Ø B.H.C	Ø B.H.	# B.H	THK1	THK2	H.D.	RF DIA	RH (RAD)	Weight lbs
SRFS0050-30	0.5	3.75	0.88	2.63	0.750	4	0.563	0.880	1.500	1.375	0.188	1.0
SRFS0075-30	0.75	4.63	1.09	3.25	0.750	4	0.625	1.000	1.875	1.688	0.188	2.0
SRFS0100-30	1	4.88	1.36	3.50	0.750	4	0.688	1.063	2.125	2.000	0.188	3.0
SRFS0125-30	1.25	5.25	1.70	3.88	0.750	4	0.750	1.063	2.500	2.500	0.188	3.5
SRFS0150-30	1.5	6.13	1.95	4.50	0.875	4	0.813	1.188	2.750	2.875	0.188	5.5
SRFS0200-30	2	6.50	2.44	5.00	0.750	8	0.875	1.313	3.313	3.625	0.188	6.5
SRFS0250-30	2.5	7.50	2.94	5.88	0.875	8	1.000	1.500	3.938	4.125	0.188	10.0
SRFS0300-30	3	8.25	3.57	6.63	0.875	8	1.125	1.688	4.625	5.000	0.188	13.0
SRFS0350-30	3.5	9.00	3.57	7.25	0.875	8	1.188	1.750	5.250	5.500	0.188	17.0
SRFS0400-30	4	10.00	4.57	7.88	0.875	8	1.250	1.875	5.750	6.188	0.188	21.0
SRFS0500-30	5	11.00	5.66	9.25	0.875	8	1.375	2.000	7.000	7.313	0.188	28.0
SRFS0600-30	6	12.50	6.72	10.63	0.875	12	1.438	2.063	8.125	8.500	0.250	35.0
SRFS0800-30	8	15.00	8.72	13.00	1.000	12	1.625	2.438	10.250	10.625	0.250	55.0
SRFS1000-30	10	17.50	10.88	15.25	1.125	16	1.875	2.625	12.625	12.750	0.250	79.0
SRFS1200-30	12	20.50	12.88	17.75	1.250	16	2.000	2.875	14.750	15.000	0.313	113.0
SRFS1400-30	14	23.00	14.14	20.25	1.250	20	2.125	3.000	16.750	16.250	0.313	158.0
SRFS1600-30	16	25.50	16.16	22.50	1.375	20	2.250	3.250	19.000	18.500	0.313	204.0
SRFS1800-30	18	28.00	18.18	24.75	1.375	24	2.375	3.500	21.000	21.000	0.313	230.0
SRFS2000-30	20	30.50	20.20	27.00	1.375	24	2.500	3.750	23.125	23.000	0.313	280.0
SRFS2400-30	24	36.00	24.25	32.00	1.625	24	2.750	4.188	27.625	27.250	0.313	396.0

Notes:

- a. Dimensions and Tolerances per ANSI B16.5.
- b. All Stainless Steel flanges available in Dual Grade 304/304L or 316/316L.
- c. ASTM A182.
- d. Meets ANSI class 300 pattern.

ALL DIMENSIONS ARE IN INCHES UNLESS OTHERWISE STATED.

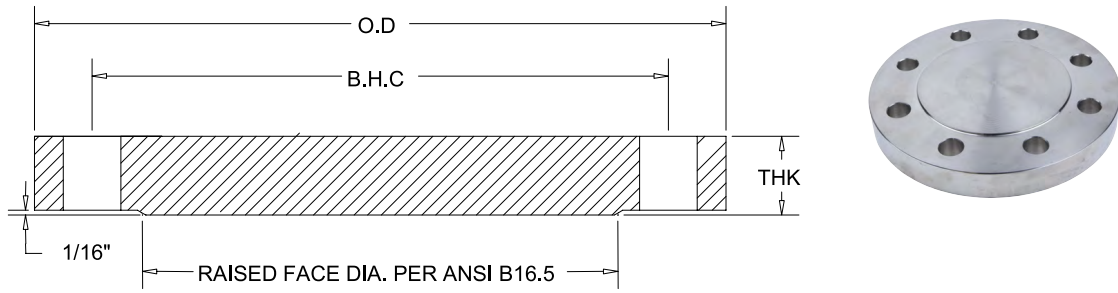

ANSI Class 300 Forged Stainless Steel Raised Face Blind Flanges

API Part Number	Size	O.D.	I.D.	Ø B.H.C	Ø B.H.	# B.H	THK	RF DIA	Weight lbs
SRFB0050-30	0.5	3.75	BLIND	2.63	0.750	4	0.563	1.375	3.0
SRFB0075-30	0.75	4.63	BLIND	3.25	0.750	4	0.625	1.688	4.0
SRFB0100-30	1	4.88	BLIND	3.50	0.750	4	0.688	2.000	5.0
SRFB0125-30	1.25	5.25	BLIND	3.88	0.750	4	0.750	2.500	5.5
SRFB0150-30	1.5	6.13	BLIND	4.50	0.875	4	0.813	2.875	6.0
SRFB0200-30	2	6.50	BLIND	5.00	0.750	8	0.875	3.625	6.5
SRFB0250-30	2.5	7.50	BLIND	5.88	0.875	8	1.000	4.125	10.0
SRFB0300-30	3	8.25	BLIND	6.63	0.875	8	1.125	5.000	15.0
SRFB0350-30	3.5	9.00	BLIND	7.25	0.875	8	1.188	5.500	21.0
SRFB0400-30	4	10.00	BLIND	7.88	0.875	8	1.250	6.188	27.0
SRFB0500-30	5	11.00	BLIND	9.25	0.875	8	1.375	7.313	39.0
SRFB0600-30	6	12.50	BLIND	10.63	0.875	12	1.438	8.500	48.0
SRFB0800-30	8	15.00	BLIND	13.00	1.000	12	1.625	10.625	75.0
SRFB1000-30	10	17.50	BLIND	15.25	1.125	16	1.875	12.750	122.0
SRFB1200-30	12	20.50	BLIND	17.75	1.250	16	2.000	15.000	180.0
SRFB1400-30	14	23.00	BLIND	20.25	1.250	20	2.125	16.250	241.0
SRFB1600-30	16	25.50	BLIND	22.50	1.375	20	2.250	18.500	312.0
SRFB1800-30	18	28.00	BLIND	24.75	1.375	24	2.375	21.000	398.0
SRFB2000-30	20	30.50	BLIND	27.00	1.375	24	2.500	23.000	500.0
SRFB2400-30	24	36.00	BLIND	32.00	1.625	24	2.750	27.250	760.0

Notes:

- a. Dimensions and Tolerances per ANSI B16.5.
- b. All Stainless Steel flanges available in Dual Grade 304/304L or 316/316L.
- c. ASTM A182.
- d. Meets ANSI class 300 pattern.

ALL DIMENSIONS ARE IN INCHES UNLESS OTHERWISE STATED.

Exhaust Flanges

Domestic & Import

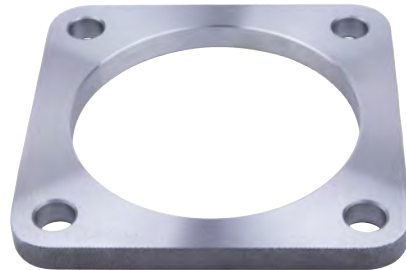
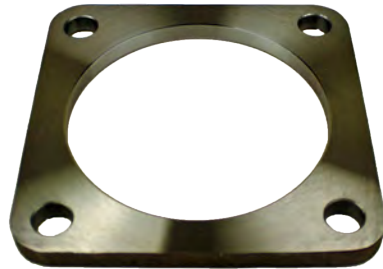

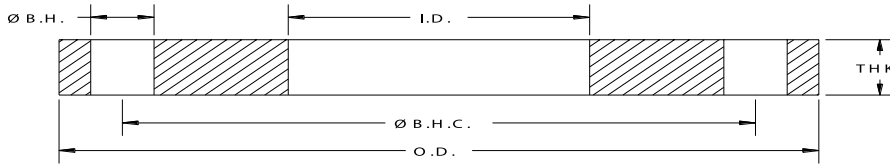

Round Exhaust Steel Flanges

API Part Number	Type	Size	O.D	I.D.	Ø B.H.C	Ø B.H	# B.H	THK	Weight lbs
PFE0300	CAT	3	5.90	3.06	4.92	0.560	4	0.500	2.50
PFE0500	CAT	5	7.72	5.06	6.86	0.410	8	0.500	3.90
PFE0800	CAT	8	11.00	8.13	9.88	0.560	8	0.500	6.25
PFE1000	CAT	10	13.50	10.13	12.44	0.500	12	0.500	9.00
PFE1200	CAT	12	16.00	12.06	14.80	0.560	12	0.500	7.25
PFE1400	CAT	14	18.00	14.06	17.00	0.560	12	0.500	14.50
PFE1600	CAT	16	23.50	16.10	21.25	0.810	16	0.500	28.80
PFE1800	CAT	18	22.50	18.13	20.88	0.630	16	0.500	19.00
PFE0500C	CUMMINS	5	8.00	5.13	7.19	0.560	8	0.500	3.30
PFE0600C	CUMMINS	6	8.00	6.13	7.19	0.560	8	0.500	2.80
PFE0600D	DETROIT	6	9.50	6.06	8.19	0.440	6	0.500	6.00
PFE1000D	DETROIT	10	13.00	10.06	11.88	0.630	8	0.500	8.00
MIT0800	MITSUBISHI	8	12.60	8.06	11.02	0.860	8	0.500	N/A
MIT1000	MITSUBISHI	10	15.16	10.00	13.56	0.870	12	0.500	N/A
MIT1200	MITSUBISHI	12	16.93	11.97	15.35	1.000	12	0.500	N/A
MIT1400	MITSUBISHI	14	18.90	14.06	17.13	1.000	12	0.500	N/A

Notes:

- a. Flange material is steel (to AWWA C207-13 specifications). Specific grades of steel for structural or critical applications are available upon request.
- b. Meets ANSI Class 150 pattern

ALL DIMENSIONS ARE IN INCHES UNLESS OTHERWISE STATED.

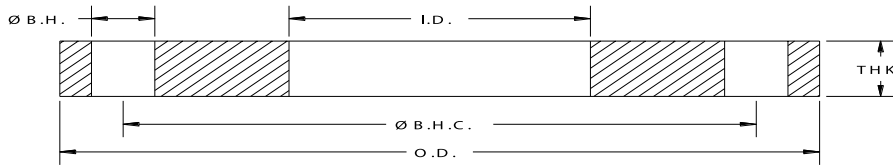

1/2" Thick Reducing Steel Flanges

API Part Number	Size	O.D.	I.D.	Ø B.H.C	Ø B.H	# B.H	THK	Weight lbs
PFHR0300-206	3 x 2	7.50	2.06	6.00	0.750	4	0.500	5.5
PFHR0400-306	4 x 3	9.00	3.06	7.50	0.750	8	0.500	8.0
PFHR0400-357	4 x 3	9.00	3.57	7.50	0.750	8	0.500	7.2
PFHR0500-306	5 x 3	10.00	3.06	8.50	0.875	8	0.500	9.5
PFHR0500-357	5 x 3	10.00	3.57	8.50	0.850	8	0.500	9.3
PFHR0500-406	5 x 4	10.00	4.06	8.50	0.875	8	0.500	8.8
PFHR0500-457	5 x 4	10.00	4.57	8.50	0.875	8	0.500	8.2
PFHR0600-406	6 x 4	11.00	4.06	9.50	0.875	8	0.500	12.0
PFHR0600-457	6 x 4	11.00	4.57	9.50	0.875	8	0.500	11.4
PFHR0600-506	6 x 5	11.00	5.06	9.50	0.875	8	0.500	10.8
PFHR0600-563	6 x 5	11.00	5.63	9.50	0.875	8	0.500	9.6
PFHR0800-406	8 x 4	13.50	4.06	11.75	0.875	8	0.500	17.7
PFHR0800-506	8 x 5	13.50	5.06	11.75	0.875	8	0.500	16.8
PFHR0800-563	8 x 5	13.50	5.63	11.75	0.875	8	0.500	16.1
PFHR0800-606	8 x 6	13.50	6.06	11.75	0.875	8	0.500	15.6
PFHR0800-672	8 x 6	13.50	6.72	11.75	0.875	8	0.500	14.7
PFHR1000-606	10 x 6	16.00	6.06	14.25	1.000	12	0.500	23.4
PFHR1000-672	10 x 6	16.00	6.72	14.25	1.000	12	0.500	26.0
PFHR1000-806	10 x 8	16.00	8.06	14.25	1.000	12	0.500	20.0
PFHR1000-872	10 x 8	16.00	8.72	14.25	1.000	12	0.500	19.3
PFHR1200-806	12 x 8	19.00	8.06	17.00	1.000	12	0.500	32.0
PFHR1200-1006	12 x 10	19.00	10.06	17.00	1.000	12	0.500	28.5
PFHR1200-1075	12 x 10	19.00	10.75	17.00	1.000	12	0.500	27.0
PFHR1200-1088	12 x 10	19.00	10.88	17.00	1.000	12	0.500	26.0
PFHR1400-806	14 x 8	21.00	8.06	18.75	1.125	12	0.500	40.1
PFHR1400-1006	14 x 10	21.00	10.06	18.75	1.125	12	0.500	36.1
PFHR1400-1206	14 x 12	21.00	12.06	18.75	1.125	12	0.500	32.0
PFHR1600-806	16 x 8	23.50	8.06	21.25	1.125	16	0.500	52.5
PFHR1600-1006	16 x 10	23.50	10.06	21.25	1.125	16	0.500	34.0
PFHR1600-1206	16 x 12	23.50	12.06	21.25	1.125	16	0.500	41.0
PFHR1600-1406	16 x 14	23.50	14.06	21.25	1.125	16	0.500	40.0
PFHR1800-1406	18 x 14	25.00	14.06	22.75	1.250	16	0.500	44.9
PFHR2000-1206	20 x 12	27.50	14.06	25.00	1.250	20	0.500	48.0
PFHR2200-2019	20x 22	29.50	20.19	27.25	1.380	20	0.500	48.5

Notes:

- a. Flange material is steel (to AWWA C207-13 specifications). Specific grades of steel for structural or critical applications are available upon request.
- b. Meets ANSI Class 150 pattern

ALL DIMENSIONS ARE IN INCHES UNLESS OTHERWISE STATED.

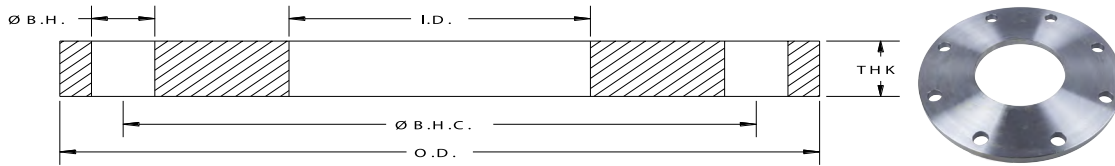

1/2" Thick Reducing Stainless Steel Flanges

API Part Number	Size	O.D.	I.D.	Ø B.H.C	Ø B.H	# B.H	THK	Weight lbs
SPFHR0500-406	5 x 4	10.00	4.06	8.50	0.88	8	0.500	9.0
SPFHR0600-406	6 x 4	11.00	4.06	9.50	0.88	8	0.500	11.0
SPFHR0600-506	6 x 5	11.00	5.06	9.50	0.88	8	0.500	10.5
SPFHR0800-506	8 x 5	13.50	5.06	11.75	0.88	8	0.500	18.0
SPFHR0800-606	8 x 6	13.50	6.06	11.75	0.88	8	0.500	16.5
SPFHR0800-672	8 x 6	13.50	6.72	11.75	0.88	8	0.500	15.0
SPFHR1000-606	10 x 6	16.00	6.06	14.25	1.00	12	0.500	18.0
SPFHR1000-806	10 x 8	16.00	8.06	14.25	1.00	12	0.500	20.0
SPFHR1200-1006	12 x 10	19.00	10.06	17.00	1.00	12	0.500	31.0
SPFHR1200-806	12 x 8	19.00	8.06	17.00	1.00	12	0.500	34.0
SPFHR1400-1288	14 x 12	21.00	12.88	18.75	1.13	12	0.500	28.0

Notes:

- a. Flange material is steel (to AWWA C207-13 specifications). Specific grades of steel for structural or critical applications are available upon request.
- b. Meets ANSI Class 150 pattern

ALL DIMENSIONS ARE IN INCHES UNLESS OTHERWISE STATED.

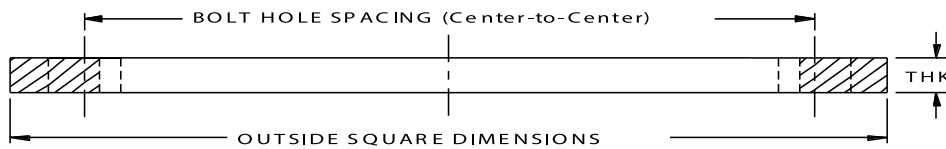

Square Exhaust Steel Flanges

API Part Number	Size	Outside Square	I.D.	Bolt Hole Spacing CTR-to-CTR	∅ B.H	# B.H	THK	Corner Radius	Weight lbs
PFES0357	3	5.50 X 5.50	3.57	4.13	0.560	4	0.500	0.688	3.0
PFES0400	4	5.50 X 5.50	4.06	4.13	0.560	4	0.500	0.688	2.6
PFES0500	5	6.50 X 6.50	5.06	5.00	0.660	4	0.500	0.688	3.0
PFES0500-75BH	5	6.50 X 6.50	5.06	5.00	0.750	4	0.500	0.688	3.0
PFES0600	6	7.75 X 7.75	6.06	6.00	0.810	4	0.500	1.000	4.5

Notes:

- a. Flange material is steel (to AWWA C207-13 specifications).
- b. Also available in 304/304L or 316/316L Stainless Steel.

ALL DIMENSIONS ARE IN INCHES UNLESS OTHERWISE STATED.

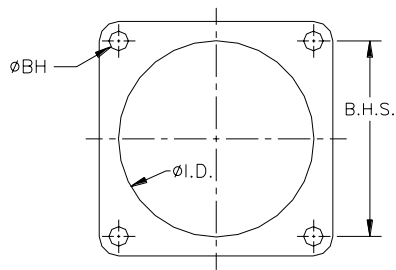

DIN Metric Flanges

Domestic & Import



=	Identical
≈	Approximate
≠	Different
∅	No Size Available

DIN (Metric) Flange Dimensions Table

CLASSES

PN10, PN16 and PN25 are classes within the Deutsches Institute fur Normung (DIN) flange specification for the pressure class and metric flange dimensions, including bolt hole diameter. We can also offer other classes upon request.

Size	PN10				PN16				PN25			
	STOCK	EN-1092	STOCK	EN-1092	STOCK	EN-1092	STOCK	EN-1092	STOCK	EN-1092	STOCK	EN-1092
25	1.38	1.36	0.630	0.630								
32	1.69	1.71	0.710	0.710								
40	1.97	1.95	0.710	0.710								
50	2.44	2.42	0.750	0.790								
65	2.95	3.05	0.790	0.790								
80	3.57	3.56	0.790	0.790								
100	4.57	4.57	0.870	0.870								
125	5.66	5.57	0.870	0.870								
150	6.72	6.71	0.950	0.950								
200	8.72	8.72	0.950	0.950								
250	10.88	10.89	1.020	1.030								
300	12.88	12.89	1.020	1.030								
350	14.19	14.15	1.180	1.190								
400	16.19	16.18	1.260	1.260								
450	18.19	18.19	1.380	1.420								
500	20.19	20.22	1.500	1.500								
600	24.19	24.27	1.650	1.660								
700	28.19	28.19	1.832	1.970								
800	32.19	32.19	2.013	2.200								
900	36.19	35.19	2.148	2.440								
1000	40.19	39.19	2.329	2.760								

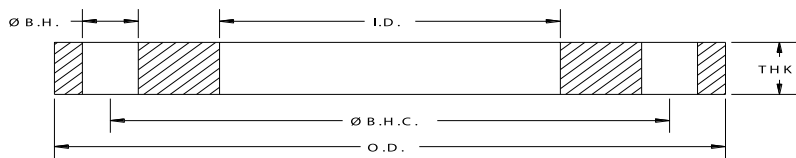

DIN Metric PN10 Steel Slip-on Flanges - EN 1092-1:2007 Spec's

API Part Number	Size		O.D.		I.D.		Ø B.H.C		Ø B.		# B.H	THK		Weight	
	in	mm	in	mm	in	mm	. in	mm	H. in	mm		in	mm	lb	kg
DN0025-PN10	1	25	4.53	115	1.36	34.5	3.35	85	0.550	14	4	0.630	16.0	2.5	1.1
DN0032-PN10	1.25	32	5.51	140	1.71	43.5	3.94	100	0.710	18	4	0.710	18.0	4.1	1.9
DN0040-PN10	1.5	40	5.91	150	1.95	49.5	4.33	110	0.710	18	4	0.710	18.0	4.6	2.1
DN0050-PN10	2	50	6.50	165	2.42	61.5	4.92	125	0.710	18	4	0.790	20.0	6.1	2.8
DN0065-PN10	2.5	65	7.28	185	3.05	77.5	5.71	145	0.710	18	4	0.790	20.0	7.3	3.3
DN0080-PN10	3	80	7.87	200	3.56	90.5	6.30	160	0.710	18	8	0.790	20.0	8.0	3.6
DN0100-PN10	4	100	8.66	220	4.57	116.0	7.09	180	0.710	18	8	0.870	22.0	9.7	4.4
DN0125-PN10	5	125	9.84	250	5.57	141.5	8.27	210	0.710	18	8	0.870	22.0	12.0	5.4
DN0150-PN10	6	150	11.22	285	6.71	170.4	9.45	240	0.870	22	8	0.944	24.0	16.0	7.3
DN0200-PN10	8	200	13.39	340	8.72	221.5	11.61	295	0.870	22	8	0.944	24.0	21.0	9.5
DN0250-PN10	10	250	15.55	395	10.89	276.5	13.78	350	0.870	22	12	1.024	26.0	26.5	12.0
DN0300-PN10	12	300	17.52	445	12.89	327.5	15.75	400	0.870	22	12	1.024	26.0	30.5	13.8
DN0350-PN10	14	350	19.88	505	14.15	359.5	18.11	460	0.870	22	16	1.181	30.0	48.0	21.8
DN0400-PN10	16	400	22.24	565	16.18	411.0	20.28	515	1.020	26	16	1.260	32.0	61.0	27.7
DN0450-PN10	18	450	24.21	615	18.19	462.0	22.24	565	1.020	26	20	1.417	36.0	74.5	33.8
DN0500-PN10	20	500	26.38	670	20.22	513.5	24.41	620	1.020	26	20	1.496	38.0	89.0	40.4
DN0600-PN10	24	600	30.71	780	24.27	616.5	28.54	725	1.180	30	20	1.654	42.0	120.0	54.5
DN0700-PN10	28	700	35.24	895	28.19	716.0	33.07	840	1.180	30	24	1.969	50.0	181.5	82.4
DN0800-PN10	32	800	39.96	1015	32.19	817.6	37.40	950	1.300	33	24	2.200	56.0	254.5	115.5
DN0900-PN10	36	900	43.90	1115	35.19	893.8	41.34	1050	1.300	33	28	2.440	62.0	348.5	158.2
DN1000-PN10	40	1000	48.42	1230	39.19	995.4	45.67	1160	1.420	36	28	2.760	70.0	462.5	210.0

DIN Metric PN16 Steel Slip-on Flanges - EN 1092-1:2007 Spec's

API Part Number	Size		O.D.		I.D.		Ø B.H.C		Ø B.		# B.H	THK		Weight	
	in	mm	in	mm	in	mm	. in	mm	H. in	mm		in	mm	lb	kg
DN0200-PN16	8	200	13.39	340	8.72	221.5	11.61	295	0.870	22	12	1.030	26	22.00	10.0
DN0250-PN16	10	250	15.94	405	10.89	276.5	13.98	355	1.020	26	12	1.150	29	31.50	14.3
DN0300-PN16	12	300	18.11	460	12.89	327.5	16.14	410	1.020	26	12	1.260	32	42.00	19.1
DN0350-PN16	14	350	20.47	520	14.14	359.0	18.50	470	1.020	26	16	1.380	35	62.50	28.4
DN0400-PN16	16	400	22.83	580	16.18	411.0	20.67	525	1.180	30	16	1.500	38	79.50	36.1
DN0450-PN16	18	450	25.20	640	18.19	462.0	23.03	585	1.180	30	20	1.660	42	102.00	46.3
DN0500-PN16	20	500	28.15	715	20.22	513.5	25.59	650	1.300	33	20	1.820	46	142.00	64.5
DN0600-PN16	24	600	33.07	840	24.27	616.5	30.31	770	1.420	36	20	2.170	55	224.50	101.9
DN0700-PN16	28	700	35.83	910	28.19	716.0	33.07	840	1.420	36	24	2.480	63	243.50	110.5
DN0800-PN16	32	800	40.35	1025	32.19	817.6	37.40	950	1.540	39	24	2.920	74	347.50	157.8
DN0900-PN16	36	900	44.29	1125	35.19	893.8	41.34	1050	1.540	39	28	3.230	82	472.00	214.3
DN1000-PN16	40	1000	49.41	1255	39.19	995.4	46.06	1170	1.650	42	28	3.550	90	655.00	297.4

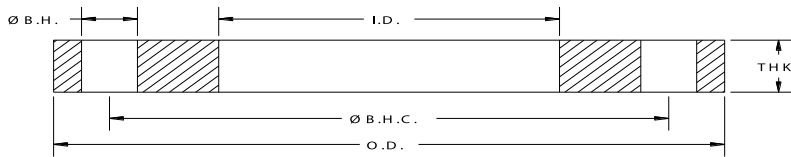

DIN Metric PN25 Steel Slip-on Flanges - EN 1092-1:2007 Spec's

API Part Number	Size		O.D.		I.D.		Ø B.H.C		Ø B.H		# B.H	THK		Weight	
	in	mm	in	mm	in	mm	. in	mm	. in	mm		in	mm	lb	kg
DN0100-PN25	4	100	9.25	235	4.57	116.0	7.48	190	0.870	22	8	1.030	26	13.5	6.1
DN0125-PN25	5	125	10.63	270	5.57	141.5	8.66	220	1.020	26	8	1.110	28	18.0	8.2
DN0150-PN25	6	150	11.81	300	6.71	170.5	9.84	250	1.020	26	8	1.180	30	23.0	10.4
DN0200-PN25	8	200	14.17	360	8.72	221.5	12.20	310	1.020	26	12	1.260	32	31.5	14.3
DN0250-PN25	10	250	16.73	425	10.89	276.5	14.57	370	1.180	30	12	1.380	35	44.5	20.2
DN0300-PN25	12	300	19.09	485	12.89	327.5	16.93	430	1.180	30	16	1.500	38	59.0	26.8
DN0350-PN25	14	350	21.85	555	14.15	359.5	19.29	490	1.300	33	16	1.660	42	92.0	41.8
DN0400-PN25	16	400	24.41	620	16.18	411.0	21.65	550	1.420	36	16	1.890	48	127.0	57.7
DN0450-PN25	18	450	26.38	670	18.19	462.0	23.62	600	1.420	36	20	2.130	54	154.0	69.9
DN0500-PN25	20	500	28.74	730	20.22	513.5	25.98	660	1.420	36	20	2.290	58	191.5	86.9
DN0600-PN25	24	600	33.27	845	24.27	616.5	30.31	770	1.540	39	20	2.680	68	280.5	127.3
DN0700-PN25	28	700	37.80	960	28.19	716.0	34.45	875	1.650	42	24	3.350	85	424.0	192.5

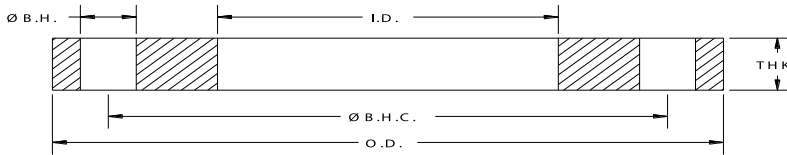

DIN Metric (PN10 Drilled) Stainless Steel Slip-on Flanges

API Part Number	Size		O.D.		I.D.		Ø B.H.C		Ø B.H		# B.H	THK		Weight	
	in	mm	in	mm	in	mm	. in	mm	. in	mm		in	mm	Lb	kg
SDN0025-PN10	1	25	4.53	115	1.38	35.10	3.35	85	0.550	14	4	0.630	16	2.5	1.1
SDN0032-PN10	1.3	32	5.51	140	1.69	42.90	3.94	100	0.710	18	4	0.710	18	3.8	1.7
SDN0040-PN10	1.5	40	5.91	150	1.97	50.00	4.33	110	0.710	18	4	0.710	18	4.3	2.0
SDN0050-PN10	2	50	6.50	165	2.44	62.00	4.92	125	0.710	18	4	0.750	19	5.8	2.6
SDN0065-PN10	2.5	65	7.28	185	2.94	74.90	5.71	145	0.710	18	4	0.790	20	7.3	3.3
SDN0080-PN10	3	80	7.87	200	3.57	90.70	6.30	160	0.710	18	8	0.790	20	8.0	3.6
SDN0100-PN10	4	100	8.66	220	4.57	116.10	7.09	180	0.710	18	8	0.870	22	9.0	4.1
SDN0125-PN10	5	125	9.84	250	5.66	143.80	8.27	210	0.710	18	8	0.870	22	13.0	5.9
SDN0150-PN10	6	150	11.22	285	6.72	170.70	9.45	240	0.870	22	8	0.950	24	15.3	6.9
SDN0200-PN10	8	200	13.39	340	8.72	221.50	11.61	295	0.870	22	8	0.950	24	21.0	9.5
SDN0250-PN10	10	250	15.55	395	10.88	276.40	13.78	350	0.870	22	12	1.020	26	26.5	12.0
SDN0300-PN10	12	300	17.52	445	12.88	327.20	15.75	400	0.870	22	12	1.020	28	30.0	13.6
SDN0350-PN10	14	350	19.88	505	14.19	360.40	18.11	460	0.870	22	16	1.180	30	44.7	20.3
SDN0400-PN10	16	400	22.24	565	16.19	411.20	20.28	515	1.020	26	16	1.260	32	60.5	27.5
SDN0450-PN10	18	450	24.21	615	18.19	462.00	22.24	565	1.020	26	20	1.380	35	72.0	32.7
SDN0500-PN10	20	500	26.38	670	20.19	512.80	24.41	620	1.020	26	20	1.500	38	90.0	40.9
SDN0600-PN10	24	600	30.71	780	24.19	614.40	28.54	725	1.160	29	20	1.650	42	121.5	55.2

DIN Metric (PN16 Drilled) Stainless Steel Slip-on Flanges

API Part Number	Size		O.D.		I.D.		Ø B.H.C		Ø B.H		# B.H	THK		Weight	
	in	mm	in	mm	in	mm	. in	mm	. in	mm		in	mm	Lb	kg
SDN0200-PN16	8	200	13.39	340	8.72	221.50	11.61	295	0.870	22	12	1.020	26	21.0	9.5
SDN0250-PN16	10	250	15.94	405	10.88	276.40	13.97	355	1.020	26	12	1.140	29	31.0	14.1
SDN0300-PN16	12	300	18.11	460	12.88	327.20	16.14	410	1.020	26	12	1.260	32	42.7	19.4
SDN0350-PN16	14	350	20.47	520	14.19	360.40	18.50	470	1.020	26	16	1.380	35	62.3	28.3
SDN0400-PN16	16	400	22.83	580	16.19	411.20	20.67	525	1.180	30	16	1.500	38	80.5	36.5
SDN0450-PN16	18	450	25.20	640	18.19	462.00	23.03	585	1.180	30	20	1.650	42	110.3	50.1
SDN0500-PN16	20	500	28.15	715	20.19	512.80	25.59	650	1.300	33	20	1.810	46	141.5	64.2
SDN0600-PN16	24	600	33.07	840	24.19	614.40	30.32	770	1.420	36	20	2.050	52	213.5	96.9

Note:

All Stainless Steel flanges available in Dual Grade 304/304L or 316/316L.

Backing Flanges & Stub Ends

Domestic & Import



Backing Flanges

PART NUMBER STRUCTURE

Part Number Section	Options
Type	Backing Flange for Angle Face Ring: ABF = Ductile Iron (Painted) SABF = Stainless Steel Backing Flange for Stub End BF = Ductile Iron (Painted) GBF = Ductile Iron (Hot Dip Galvanized)
Size	XXXX = Size in inches going out 2 decimal places
Other	16 = O.D. Tube Size DI = Ductile Iron

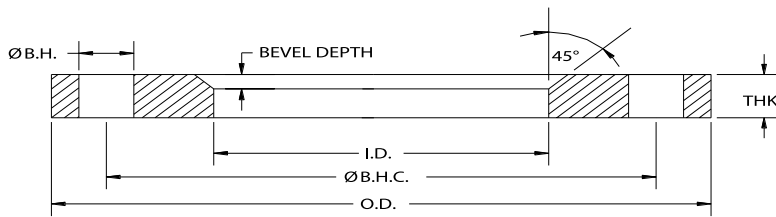

DUCTILE IRON BACKING FLANGES FOR ANGLE FACE RINGS

API Part Number	Size	O.D.	I.D.	Ø B.H.C.	Ø B.H.	# B.H	THK	Bevel Depth	Weight lbs
ABF0050-DI	0.5	3.50	1.25	2.38	0.630	4	0.500	0.250	0.9
ABF0075-DI	0.75	3.88	1.44	2.75	0.630	4	0.500	0.250	1.1
ABF0100-DI	1	4.25	1.69	3.13	0.630	4	0.500	0.250	1.3
ABF0125-DI	1.25	4.63	2.06	3.50	0.630	4	0.500	0.250	1.5
ABF0150-DI	1.5	5.00	2.25	3.88	0.630	4	0.500	0.250	1.9
ABF0200-DI	2	6.00	2.88	4.75	0.750	4	0.500	0.250	2.5
ABF0250-DI	2.5	7.00	3.38	5.50	0.750	4	0.500	0.250	3.5
ABF0300-DI	3	7.50	4.00	6.00	0.750	4	0.500	0.250	4.0
ABF0400-DI	4	9.00	5.00	7.50	0.750	8	0.562	0.250	6.5
ABF0600-DI	6	11.00	7.25	9.50	0.875	8	0.630	0.250	8.0
ABF0800-DI	8	13.50	9.25	11.75	0.875	8	0.630	0.250	11.5
ABF1000-DI	10	16.00	11.44	14.25	1.000	12	0.630	0.312	15.0
ABF1200-DI	12	19.00	13.63	17.00	1.000	12	0.750	0.312	26.0
ABF1400-DI	14	21.00	14.88	18.75	1.125	12	0.750	0.312	26.5
ABF1600-DI	16	23.50	16.88	21.25	1.125	16	0.750	0.312	37.0
ABF1800-DI	18	25.00	18.88	22.75	1.250	16	0.880	0.375	42.0
ABF2000-DI	20	27.50	20.88	25.00	1.250	20	0.880	0.375	51.0
ABF2400-DI	24	32.00	24.88	29.50	1.375	20	1.000	0.375	76.0
ABF3000-DI	30	38.75	30.88	36.00	1.375	28	1.000	0.500	104.0
ABF3600-DI	36	46.00	36.88	42.75	1.625	32	1.250	0.500	166.0
ABF4200-DI	42	53.00	42.91	49.50	1.625	36	1.250	0.500	208.0
ABF4800-DI	48	59.50	48.91	56.00	1.625	44	1.250	0.500	246.0

Notes:

- a. Material conforms to ASTM A536.
- b. Meets ANSI class 150 pattern.

ALL DIMENSIONS ARE IN INCHES UNLESS OTHERWISE STATED.

DC# 0524

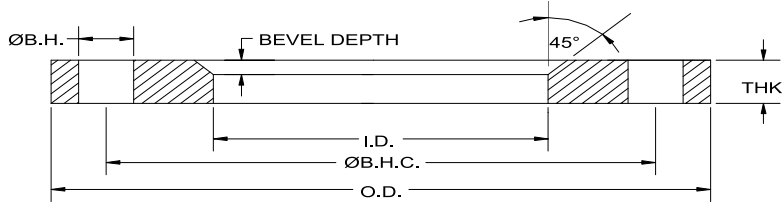

STAINLESS STEEL BACKING FLANGES FOR ANGLE FACE RINGS

API Part Number	Size	O.D.	I.D.	Ø B.H.C.	Ø B.H.	# B.H	THK	Bevel Depth	Weight lbs
SABF0050	0.5	3.50	1.25	2.38	0.630	4	0.500	0.250	0.9
SABF0075	0.75	3.88	1.44	2.75	0.630	4	0.500	0.250	1.1
SABF0100	1	4.25	1.69	3.13	0.630	4	0.500	0.250	1.3
SABF0125	1.25	4.63	2.06	3.50	0.630	4	0.500	0.250	1.5
SABF0150	1.5	5.00	2.25	3.88	0.630	4	0.500	0.250	1.9
SABF0200	2	6.00	2.88	4.75	0.750	4	0.500	0.250	2.5
SABF0250	2.5	7.00	3.38	5.50	0.750	4	0.500	0.250	3.5
SABF0300	3	7.50	4.00	6.00	0.750	4	0.500	0.250	4.0
SABF0400	4	9.00	5.00	7.50	0.750	8	0.562	0.250	6.0
SABF0500	5	10.00	6.06	8.50	0.875	8	0.500	0.250	6.5
SABF0600	6	11.00	7.25	9.50	0.875	8	0.630	0.250	8.0
SABF0800	8	13.50	9.25	11.75	0.875	8	0.630	0.250	11.5
SABF1000	10	16.00	11.44	14.25	1.000	12	0.630	0.312	15.0
SABF1200	12	19.00	13.63	17.00	1.000	12	0.630	0.312	26.0
SABF1400	14	21.00	14.88	18.75	1.125	12	0.630	0.312	26.5
SABF1600	16	23.50	16.88	21.25	1.125	16	0.750	0.312	37.0
SABF1800	18	25.00	18.88	22.75	1.250	16	0.880	0.375	42.0
SABF2000	20	27.50	20.88	25.00	1.250	20	0.880	0.375	51.0
SABF2400	24	32.00	24.88	29.50	1.375	20	1.000	0.375	76.0
SABF3000	30	38.75	30.88	36.00	1.375	28	1.000	0.500	104.0
SABF3600	36	46.00	36.88	42.75	1.625	32	1.250	0.500	166.0
SABF4200	42	53.00	42.91	49.50	1.625	36	1.250	0.500	220.0
SABF4800	48	59.50	48.91	56.00	1.625	44	1.250	0.500	262.0

Note:

- a. All Stainless Steel flanges available in Dual Grade 304/304L or 316/316L.
- b. Meets ANSI class 150 pattern.

ALL DIMENSIONS ARE IN INCHES UNLESS OTHERWISE STATED.

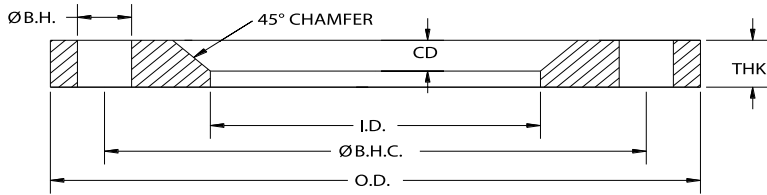

DUCTILE IRON BACKING FLANGES FOR STUB ENDS

API Part Number	Size	O.D.	I.D.	Ø B.H.C.	Ø B.H.	# B.H	THK	Bevel Depth	Weight lbs
(G)BF0050-DI	0.5	3.50	0.91	2.38	0.630	4	0.438	0.130	1.2
(G)BF0075-DI	0.75	3.88	1.11	2.75	0.630	4	0.500	0.130	1.3
(G)BF0100-DI	1	4.25	1.38	3.13	0.630	4	0.500	0.130	1.6
(G)BF0125-DI	1.25	4.63	1.72	3.50	0.630	4	0.500	0.190	1.9
(G)BF0150-DI	1.5	5.00	1.97	3.88	0.630	4	0.500	0.250	2.6
(G)BF0200-DI	2	6.00	2.46	4.75	0.750	4	0.500	0.320	2.7
(G)BF0250-DI	2.5	7.00	2.97	5.50	0.750	4	0.500	0.320	2.8
(G)BF0300-DI	3	7.50	3.60	6.00	0.750	4	0.500	0.380	4.5
(G)BF0400-DI	4	9.00	4.60	7.50	0.750	8	0.563	0.440	6.1
(G)BF0500-DI	5	10.00	5.69	8.50	0.875	8	0.630	0.440	7.2
(G)BF0600-DI	6	11.00	6.75	9.50	0.875	8	0.630	0.440	8.4
(G)BF0800-DI	8	13.50	8.75	11.75	0.875	8	0.630	0.440	12.8
(G)BF1000-DI	10	16.00	10.92	14.25	1.000	12	0.630	0.440	14.2
(G)BF1200-DI	12	19.00	12.92	17.00	1.000	12	0.750	0.440	26.8
(G)BF1400-DI	14	21.00	14.19	18.75	1.125	12	0.750	0.440	38.0
(G)BF1600-DI	16	23.50	16.19	21.25	1.125	16	0.750	0.440	39.0
(G)BF1800-DI	18	25.00	18.20	22.75	1.250	16	0.880	0.440	47.0
(G)BF2000-DI	20	27.50	20.25	25.00	1.250	20	0.880	0.440	57.0
(G)BF2400-DI	24	32.00	24.25	29.50	1.375	20	1.000	0.440	79.0
(G)BF3000-DI	30	38.75	30.38	36.00	1.375	28	1.000	0.440	117.0
(G)BF3600-DI	36	46.00	36.50	42.75	1.625	32	1.125	0.440	181.0

Notes:

- a. Material conforms to ASTM A536.
- b. Meets ANSI class 150 pattern.
- c. Available with a paint or hot dip galvanized coating.

ALL DIMENSIONS ARE IN INCHES UNLESS OTHERWISE STATED.

Stub Ends

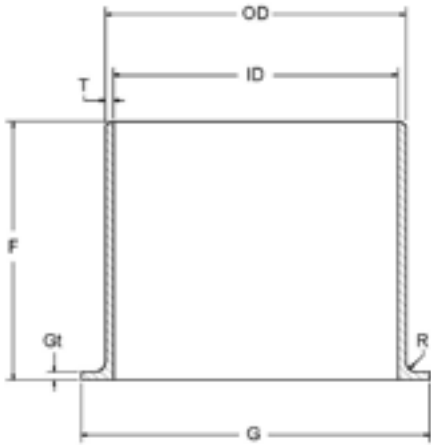

Size	Outside Diameter (O.D.)		Inside Diameter (I.D.)		Wall thickness (T)		Diameter (G)		Thickness (Gt)		Length (F)		Radius (R)											
	Std		Std		Std		Std		Std		Std		Min	Max										
	Min	Max	Min	Max	Min	Max	Min	Max	Min	Max	Min	Max												
1	1.315		1.097		0.109		2.000		0.109		2		0.059	0.157										
	1.283	1.346	1.067	1.126	0.098	0.122	1.969	2.031	0.098	0.165	1.941	2.059												
1.5	1.902		1.683		0.109		2.874		0.109		2				0.079	0.197								
	1.871	1.933	1.654	1.713	0.098	0.122	2.843	2.906	0.098	0.165	1.941	2.059												
2	2.374		2.156		0.109		3.626		0.109		2.5						0.079	0.197						
	2.343	2.421	2.126	2.201	0.098	0.122	3.594	3.657	0.098	0.165	2.441	2.559												
2.5	2.874		2.634		0.120		4.106		0.120		2.5								0.079	0.197				
	2.843	2.921	2.602	2.681	0.106	0.134	4.075	4.138	0.106	0.177	2.441	2.559												
3	3.500		3.260		0.120		5.000		0.122		2.5										0.079	0.197		
	3.469	3.547	3.197	3.323	0.106	0.134	4.969	5.031	0.106	0.177	2.441	2.559												
4	4.500		4.260		0.120		6.189		0.120		3												0.079	0.197
	4.469	4.547	4.197	4.323	0.106	0.134	6.157	6.220	0.106	0.177	2.941	3.059												
5	5.563		5.295		0.134		7.315		0.134		3		0.079	0.197										
	5.531	5.622	5.232	5.358	0.118	0.150	7.283	7.349	0.118	0.193	2.941	3.059												
6	6.626		6.358		0.134		8.500		0.134		3.5				0.079	0.197								
	6.594	6.685	6.295	6.421	0.118	0.150	8.469	8.531	0.118	0.193	3.441	3.559												
8	8.626		8.330		0.148		10.626		0.148		4						0.079	0.197						
	8.594	8.720	8.268	8.390	0.130	0.165	10.591	10.660	0.131	0.204	3.909	4.091												
10	10.752		10.422		0.1649		12.752		0.165		5								0.079	0.197				
	10.721	10.850	10.300	10.540	0.146	0.185	12.721	12.78	0.146	0.224	4.909	5.091												
12	12.752		12.392		0.180		15.000		0.180		6										0.079	0.197		
	12.721	12.850	12.271	12.510	0.157	0.201	14.971	15.030	0.157	0.236	5.909	6.091												

PART NUMBER STRUCTURE

Part Number Section	Options
Category	SE = Stub End
Size	XXXX = Size in inches going out 2 decimal places
Type	C = Type C
Schedule	10S = Schedule 10
Material	304L = 304L Stainless Steel
Example	SE0100-C-10S-304L = 1" Stub End, Type C, Schedule 10, 304L Stainless Steel

Notes:

- a. Product Specification For Lap Joint Type C MSS SP-43 Schedule:10S. Other Types, Schedules and sizes available upon request.
- b. Standard material is 304L Stainless Steel, but available in other materials on request.

ALL DIMENSIONS ARE IN INCHES UNLESS OTHERWISE STATED.

Valves & Accessories



Wafer Style Butterfly Valves

PART NUMBER STRUCTURE

Part Number Section	Options
Type	BVG = Gear Operated Butterfly Valve BVL = Lever Operated Butterfly Valve
Size	XXXX = Size in inches going out 2 decimal places
Disc Material	NPDI = Nickel Plated Ductile Iron
Seat Material	BN = NBR

FEATURES

- Operator flange conforms to ISO 5211. Designed to work with manual, pneumatic or electric actuators. The rubber seat is non-collapsible, stretch resistant, and blowout proof.
- The precision machined disc ensures low operating torque and effective sealing up to 200 psi. The hydro-dynamically designed disc allows for high capacity flow.
- One piece shaft design ensures dependability and positive disc positioning.
- Valves are epoxy coated and incorporate “zerk” style grease fittings for easy lubrication on neck & gearbox (if applicable).

MATERIALS

Part	Material
Body	Epoxy Coated Ductile Iron
Disc	Nickel Plated Ductile Iron
Shaft	400 Series Stainless
Seat	NBR
Pin	Stainless Steel

OPERATING CONDITIONS

Nominal Size		2 - 12	14 - 28
Operating Pressure		200 psi	150 psi
Test Pressure	Shell	300 psi	300 psi
	Seat	220 psi	170 psi
Working Temp.	NBR Seat	25° - 190°F	25° - 190°F

Notes:

- Disc materials is also available in Aluminum Bronze and Stainless Steel (may be subject to minimum order quantity)
- Seat is available in other materials including EPDM (may be subject to minimum order quantity)
- Shorter levers are available for sizes 6" to 12".

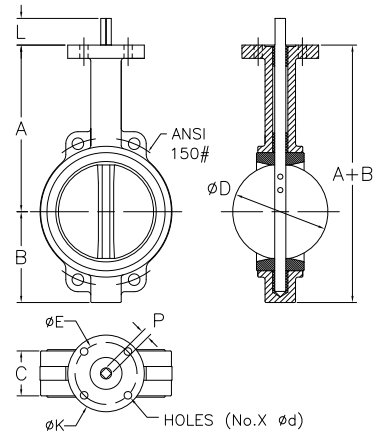
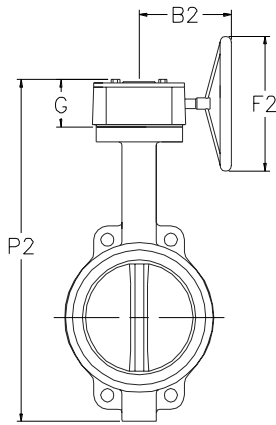

WAFER STYLE BUTTERFLY VALVE - GEAR OPERATOR

API Part Number	Size	A	B	A + B	C	ØE	ØK	L	P	Holes (No. x Ød)	B2	G	P2	F2
BVG0200-NPDI-BN	2	5.55	2.80	8.35	1.69	1.97	2.56	1.18	0.354	4 x 0.276	6.06	2.52	10.87	5.91
BVG0250-NPDI-BN	2.5	6.06	2.87	8.94	1.81	1.97	2.56	1.18	0.354	4 x 0.276	6.06	2.52	11.46	5.91
BVG0300-NPDI-BN	3	6.18	3.90	10.08	1.81	1.97	2.56	1.18	0.354	4 x 0.276	6.06	2.52	12.60	5.91
BVG0400-NPDI-BN	4	6.89	4.49	11.38	2.05	2.76	3.54	1.18	0.433	4 x 0.394	6.06	2.52	13.90	5.91
BVG0500-NPDI-BN	5	7.36	5.00	12.36	2.20	2.76	3.54	1.18	0.551	4 x 0.394	6.06	2.52	14.88	5.91
BVG0600-NPDI-BN	6	8.07	5.51	13.58	2.20	2.76	3.54	1.18	0.551	4 x 0.394	6.06	2.52	16.10	5.91
BVG0800-NPDI-BN	8	9.21	6.89	16.10	2.36	4.02	4.92	1.34	0.669	4 x 0.472	8.82	2.91	19.01	11.22
BVG1000-NPDI-BN	10	10.98	8.27	19.25	2.68	4.02	4.92	1.34	0.866	4 x 0.472	8.82	2.91	22.16	11.22
BVG1200-NPDI-BN	12	12.32	9.65	21.97	3.07	4.02	4.92	1.34	0.866	4 x 0.472	8.46	2.95	24.92	11.22
BVG1400-NPDI-BN	14	14.17	10.51	24.69	3.07	4.92	5.91	1.77	0.866	4 x 0.551	8.27	5.04	29.73	11.22
BVG1600-NPDI-BN	16	15.47	12.01	27.48	4.02	5.51	6.89	2.05	1.063	4 x 0.709	10.16	5.04	32.52	11.22
BVG1800-NPDI-BN	18	16.38	12.76	29.13	4.49	5.51	6.89	2.05	1.063	4 x 0.709	10.16	5.04	34.17	11.22
BVG2000-NPDI-BN	20	18.35	14.25	32.60	5.00	5.51	6.89	2.52	1.063	4 x 0.709	11.22	5.04	37.64	15.16
BVG2400-NPDI-BN	24	22.13	17.48	39.61	6.06	6.50	8.27	2.76	1.417	4 x 0.866	11.22	5.51	45.12	15.16
BVG2800-NPDI-BN	28	24.63	20.50	45.13	6.50	10.00	11.81	3.74	2.490	8 x 0.709	14.13	6.22	51.38	16.75

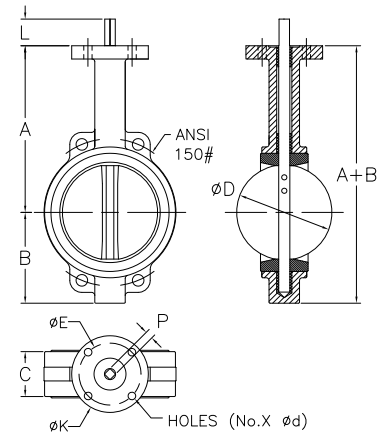
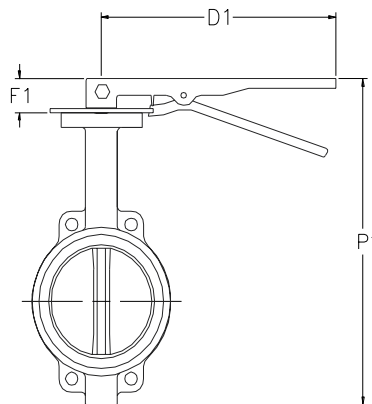

WAFER STYLE BUTTERFLY VALVE - LEVER OPERATOR

API Part Number	Size	A	B	A + B	C	ØE	ØK	L	P	Holes (No. x Ød)	P1	D1	F1
BVL0200-NPDI-BN	2	5.55	2.80	8.35	1.69	1.97	2.56	1.18	0.354	4 x 0.276	9.44	10.47	1.18
BVL0250-NPDI-BN	2.5	6.06	2.87	8.94	1.81	1.97	2.56	1.18	0.354	4 x 0.276	10.09	10.47	1.18
BVL0300-NPDI-BN	3	6.18	3.90	10.08	1.81	1.97	2.56	1.18	0.354	4 x 0.276	11.22	10.47	1.18
BVL0400-NPDI-BN	4	6.89	4.49	11.38	2.05	2.76	3.54	1.18	0.433	4 x 0.394	12.47	10.47	1.18
BVL0500-NPDI-BN	5	7.36	5.00	12.36	2.20	2.76	3.54	1.18	0.551	4 x 0.394	13.62	10.47	1.18
BVL0600-NPDI-BN	6	8.07	5.51	13.58	2.20	2.76	3.54	1.18	0.551	4 x 0.394	14.87	10.47	1.18
BVL0800-NPDI-BN	8	9.21	6.89	16.10	2.36	4.02	4.92	1.34	0.669	4 x 0.472	17.35	14.17	1.34
BVL1000-NPDI-BN	10	10.98	8.27	19.25	2.68	4.02	4.92	1.34	0.866	4 x 0.472	20.19	14.17	1.34
BVL1200-NPDI-BN	12	12.32	9.65	21.97	3.07	4.02	4.92	1.34	0.866	4 x 0.472	24.03	19.69	1.34

ALL DIMENSIONS ARE IN INCHES UNLESS OTHERWISE STATED.

DC# 0624

Valve Extensions (For Butterfly Valves)

FEATURES

- Valve extensions can be used for underground service or in riser systems to enable easier access for opening and shutting butterfly valves.
- Galvanized steel for excellent corrosion resistance.

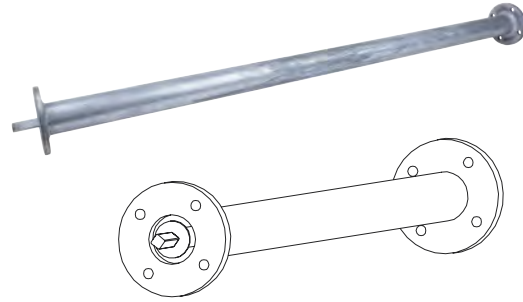

ALL DIMENSIONS ARE IN INCHES UNLESS OTHERWISE STATED.

COMPLETE SET INFORMATION (VE-D):

Complete Set Part Number	Valve/Extension Size	Extension Shaft Part Number	Extension Housing Part Number
VE0400D-XX	4	VEIS4D-XX	VEHS-XX
VE0500D-XX	5	VEIS56D-XX	VEHS-XX
VE0600D-XX	6	VEIS56D-XX	VEHS-XX
VE0800D-XX	8	VEIS8D-XX	VEHL-XX
VE1000D-XX	10	VEIS1012D-XX	VEHL-XX
VE1200D-XX	12	VEIS1012D-XX	VEHL-XX

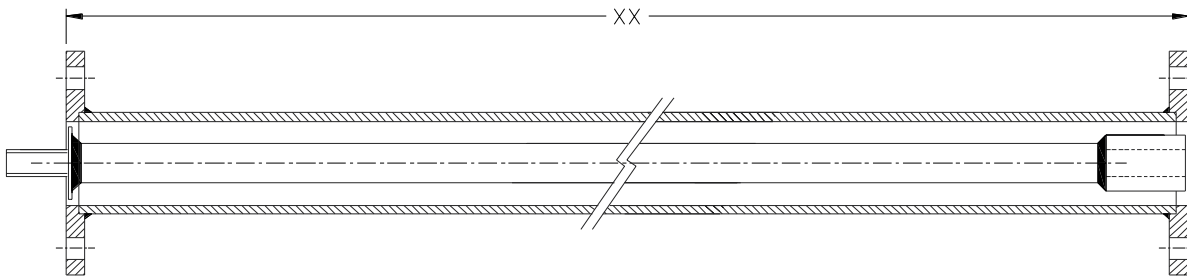

Shaft Information (VEIS-D)

Housing Part Number	Size	Diagonal Head Size (E)
VEIS4D-XX	4	0.433
VEIS56D-XX	5	0.551
VEIS56D-XX	6	0.551
VEIS8D-XX	8	0.669
VEIS1012D-XX	10	0.866
VEIS1012D-XX	12	0.866

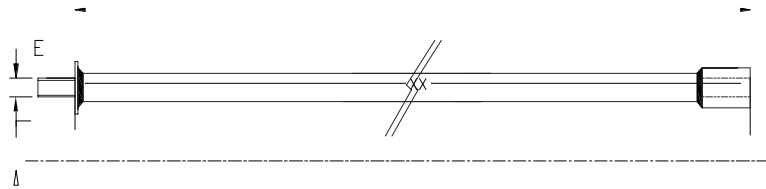

Housing Information (VEH)

Housing Part Number	Size	Bolt Circle Diameter (Øb)
VEHS-XX	4	2.76
VEHS-XX	5	2.76
VEHS-XX	6	2.76
VEHL-XX	8	4.02
VEHL-XX	10	4.02
VEHL-XX	12	4.02

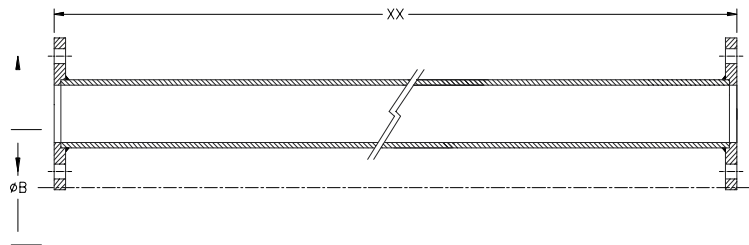

Note:
a. "XX" = Length of Valve Extension (36", 48", or 72").
b. Valve extensions are for BVL and BVG product lines.

Double Door Check Valves

FEATURES

- Small, lightweight, and easy to maintain.
- Two torsion springs close valve plates quickly and automatically.
- Quick spring action prevents back-flow, eliminates water hammering, and provides minimal head loss.
- Valve can be installed vertically or horizontally.
- Applications include HVAC, compressed air; Water supply and discharge; Irrigation and reclaim water; Process water.

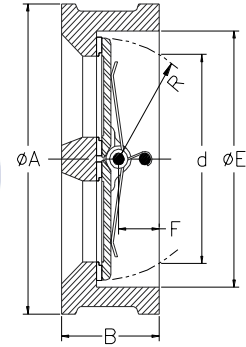

ALL DIMENSIONS ARE IN INCHES UNLESS OTHERWISE STATED.

DIMENSIONS

API Part Number	Size	B	ØE	ØA	Approximate Weight lbs
CV0200-XXXX-EP	2	1.69	2.56	4.02	3.3
CV0250-XXXX-EP	2.5	1.81	3.15	4.76	5.3
CV0300-XXXX-EP	3	2.52	3.70	5.24	7.9
CV0400-XXXX-EP	4	2.52	4.61	6.73	12.6
CV0500-XXXX-EP	5	2.76	5.71	7.60	16.1
CV0600-XXXX-EP	6	2.99	6.73	8.62	19.8
CV0800-XXXX-EP	8	3.50	8.82	10.87	37.5
CV1000-XXXX-EP	10	4.49	10.43	13.23	57.3
CV1200-XXXX-EP	12	4.49	12.20	15.98	92.6
CV1400-XXXX-EP	14	5.00	14.17	17.64	121.3
CV1600-XXXX-EP	16	5.51	16.14	20.12	165.3
CV1800-XXXX-EP	18	5.98	17.87	21.50	225.0
CV2000-XXXX-EP	20	5.98	19.88	23.74	236.0
CV2400-XXXX-EP	24	7.01	24.61	28.11	365.0

PART NUMBER STRUCTURE

Part Number Section	Options
Type	CV = Check Valve
Size	XXXX = Size in inches going out 2 decimal places
Disc Material *Denoted with "XXXX"	NPDI = Nickel Plated Ductile Iron 304 = 304 Stainless Steel
Seat Material	EP = EPDM

OPERATING CONDITIONS

Nominal Size	2 - 18		20 - 24		
	Operating Pressure	200 psi		150 psi	
Test Pressure	Shell	300 psi		225 psi	
	Seat	220 psi		168 psi	
Working Temp.	EPDM Seat	10° - 250° F		10° - 250° F	

Notes:

- Not for use in Oil & Gas industries.
- Valve seat is available in other materials including Neoprene and NBR (may be subject to minimum order quantity)

MATERIALS

Part	Material
Body	Cast Iron - ASTM A126 Cl. B
Disc	Nickel Plated Ductile Iron or 304 Stainless Steel
Hinge Pin	Stainless Steel
Stop Pin	Stainless Steel
Spring	Stainless Steel
Seat	EPDM
Shaft end Plug	Mild/Carbon Steel
Finish	Epoxy Coated - Blue

REPLACEMENT SPRING KITS

API Part Number	DESCRIPTION
CVK0400	4" KIT (1 SHAFT; 2 SPRINGS)
CVK0600	6" KIT (1 SHAFT; 2 SPRINGS)
CVK0800	8" KIT (1 SHAFT; 2 SPRINGS)
CVK1000	10" KIT (1 SHAFT; 2 SPRINGS)
CVK1200	12" KIT (1 SHAFT; 2 SPRINGS)
CVK1400	14" KIT (1 SHAFT; 2 SPRINGS)
CVK1600	16" KIT (1 SHAFT; 2 SPRINGS)

DC# 0624

Rubber Expansion Joints & Accessories



Rubber Expansion Joints - *Flange x Flange* For Series: AMS, AMT, SAMS, & SAMT

PART NUMBER STRUCTURE

Part Number Section	Options
Type	AMS = Single Sphere (Steel) SAMS = Single Sphere (Stainless Steel) AMT = Twin Sphere (Steel) SAMT = Twin Sphere (Stainless Steel)
Size	XXXX = Size in inches going out 2 decimal places
Body Material	NE = Neoprene EP = EPDM BN = Buna-N/Nitrile/NBR
Flange Material	STL = Zinc Plated Steel 304L = 304L Stainless Steel 316L = 316L Stainless Steel
Class	150 = 150# Drilling 300 = 300# Drilling PXX = DIN PN10/PN16Drilling (available upon request)
Example	AJS0200-NE-STL-150 = Single Sphere Expansion Joint with Neoprene Body and Steel Flanges with 150# Drill Pattern

OPERATING CONDITIONS

Size Range	1" - 12"	14" - 24"
Operating Pressure	up to 214 psi	up to 114 psi
Operating Temp Range*	14 °F- 170 °F (Neoprene) 14 °F- 210 °F (EPDM) 14 °F- 170 °F (Buna-N/Nitrile/NBR)	
Burst Pressure	853 psi	340 psi
Vacuum Rating*	Contact API Sales	

MATERIALS

Part	Part Description	Material
1	Flanges	Mild Steel - Zinc Plated steel or Stainless Steel
2	Reinforcing Wire	Mild Steel
3	Tube	Synthetic Rubber
4	Cover	Synthetic Rubber
5	Reinforcing Cord	Synthetic Fiber

** - Warnings:

- a. Pressure ratings listed in the above table are for temperatures up to 110 °F. For temperature service above 125 °F, please contact API Sales for actual working pressure ratings.
- b. Limit rods are required in systems that are unanchored and recommended in all other applications.
- c. Not for use in steam applications

Single Sphere Rubber Expansion Joints - *Flange x Flange* (AMS & SAMS Series)

FEATURES

- Applicable for suction and delivery (discharge).
- Provides sound and vibration isolation.
- Gaskets and packing are not required.
- Floating flanges allow for easy installation.
- Prevents piping system and equipment breakdown by absorbing elongation and contraction caused by temperature variances.
- Absorbs water pulsation and minimizes water hammering.
- DIN drilled flanges available upon request (See DIN Flange section for dimensions)

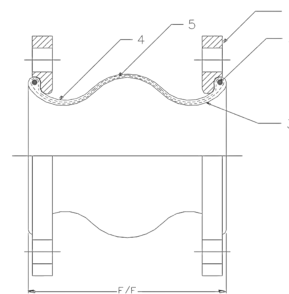

APPLICATIONS

- Pumps & air compressors in air conditioning system & sanitary equipment.
- Refrigeration systems and blowers in industrial plant equipment.
- Feed-water and drainage equipment in marine piping systems.
- Applicable for use in power generation and chemical plants.

DIMENSION & ALLOWABLE MOVEMENTS

ALL DIMENSIONS ARE IN INCHES UNLESS OTHERWISE STATED.

API Part Number	Size	Face to Face Dimensions	Allowable Motion Ratings*				Installation Tolerances			
			Compression	Elongation	Lateral	Angular	Compression	Elongation	Lateral	Angular
(S)AMS0100	1	6	0.50	0.38	0.50	15°	0.19	0.13	0.25	5°
(S)AMS0125	1.25	6	0.50	0.38	0.50	15°	0.19	0.13	0.25	5°
(S)AMS0150	1.5	6	0.50	0.38	0.50	15°	0.19	0.13	0.25	5°
(S)AMS0200	2	6	0.50	0.38	0.50	15°	0.19	0.13	0.25	5°
(S)AMS0250	2.5	6	0.50	0.38	0.50	15°	0.19	0.13	0.25	5°
(S)AMS0300	3	6	0.50	0.38	0.50	15°	0.19	0.13	0.25	5°
(S)AMS0400	4	6	0.63	0.38	0.50	15°	0.19	0.13	0.25	5°
(S)AMS0500	5	6	0.63	0.38	0.50	15°	0.19	0.13	0.25	5°
(S)AMS0600	6	6	0.63	0.38	0.50	15°	0.19	0.13	0.25	5°
(S)AMS0800	8	6	0.63	0.38	0.50	15°	0.19	0.13	0.25	5°
(S)AMS1000	10	8	0.63	0.50	0.75	15°	0.19	0.13	0.25	5°
(S)AMS1200	12	8	0.75	0.50	0.75	15°	0.19	0.13	0.25	5°
(S)AMS1400	14	8	0.75	0.50	0.75	15°	0.19	0.13	0.25	5°
(S)AMS1600	16	8	0.75	0.50	0.75	15°	0.19	0.13	0.25	5°
(S)AMS1800	18	8	0.75	0.50	0.75	15°	0.19	0.13	0.25	5°
(S)AMS2000	20	8	0.75	0.50	0.75	15°	0.19	0.13	0.25	5°
(S)AMS2400	24	10	0.75	0.50	0.75	15°	0.19	0.13	0.25	5°

Warning: Do not elongate rubber expansion joints when installing for suction service. “**” - Non Concurrent Ratings.

Notes:

- a. For all expansion joint configurations - See section 10.02

Twin Sphere Rubber Expansion Joints - *Flange x Flange* (AMT & SAMT Series)

FEATURES

- Applicable for suction and delivery (discharge).
- Designed for greater compression, elongation, and angular movement than the single sphere expansion joint.
- Excellent for absorbing thermal expansion and eliminating sound and vibration.
- Gaskets and packing not required.
- Good electrical insulator.
- Absorbs water pulsation and minimizes water hammering.
- DIN drilled flanges available upon request (See DIN Flange section for dimensions)

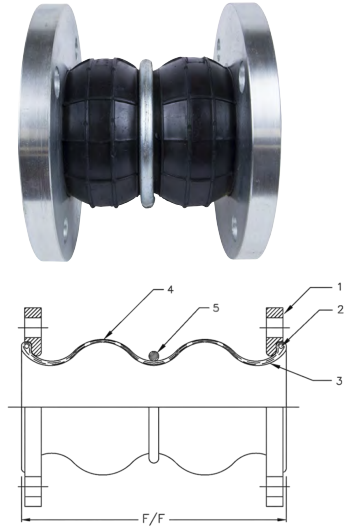

APPLICATIONS

- Pressure piping systems in building equipment and general industrial plants.
- Pump and turbine lines used for power generation plants, industrial machinery and universal pump blowers.
- Feed-water & drainage lines for waterworks & sanitary piping systems.
- Pipelines for industrial plants and shipbuilding yards.

DIMENSION & ALLOWABLE MOVEMENTS

ALL DIMENSIONS ARE IN INCHES UNLESS OTHERWISE STATED.

API Part Number	Size	Face to Face Dimensions	Allowable Motion Ratings*				Installation Tolerances			
			Compression	Elongation	Lateral	Angular	Compression	Elongation	Lateral	Angular
(S)AMT0100	1	5.00	1.50	0.75	1.25	35°	0.25	0.13	0.31	10°
(S)AMT0125	1.25	7.00	1.50	0.75	1.25	35°	0.25	0.13	0.31	10°
(S)AMT0150	1.5	7.00	2.00	1.13	1.75	35°	0.25	0.13	0.31	10°
(S)AMT0200	2	7.00	2.00	1.13	1.75	35°	0.25	0.13	0.31	10°
(S)AMT0250	2.5	7.00	2.00	1.13	1.75	35°	0.25	0.13	0.31	10°
(S)AMT0300	3	7.00	2.00	1.38	1.75	35°	0.25	0.13	0.31	10°
(S)AMT0400	4	9.00	2.00	1.38	1.56	35°	0.25	0.13	0.31	10°
(S)AMT0500	5	9.00	2.00	1.38	1.56	30°	0.25	0.13	0.38	10°
(S)AMT0600	6	9.00	2.00	1.38	1.56	30°	0.25	0.13	0.38	10°
(S)AMT0800	8	13.00	2.38	1.38	1.38	30°	0.25	0.13	0.50	10°
(S)AMT1000	10	13.00	2.38	1.38	1.38	30°	0.25	0.13	0.50	10°
(S)AMT1200	12	13.00	2.38	1.38	1.38	20°	0.25	0.13	0.50	10°
(S)AMT1400	14	13.75	1.56	1.13	1.13	20°	0.25	0.13	0.31	10°
(S)AMT1600	16	13.75	1.56	1.13	1.13	20°	0.25	0.13	0.31	10°
(S)AMT1800	18	13.75	1.56	1.13	1.13	20°	0.25	0.13	0.31	10°
(S)AMT2000	20	13.75	1.56	1.13	1.13	20°	0.25	0.13	0.31	10°
(S)AMT2400	24	13.75	1.56	1.13	1.13	20°	0.25	0.13	0.31	10°

Warning: Do not elongate rubber expansion joints when installing for suction service.

* - Non Concurrent Ratings.

Notes:

- a. For all expansion joint configurations - See section 10.02

Rubber Expansion Joints - *Flange x Flange*

For Series: AJS, AJT, SAJS, & SAJT

PART NUMBER STRUCTURE

Part Number Section	Options
Type	AJS = Single Sphere (Steel) SAJS = Single Sphere (Stainless Steel) AJT = Twin Sphere (Steel) SAJT = Twin Sphere (Stainless Steel)
Size	XXXX = Size in inches going out 2 decimal places
Body Material	NE = Neoprene EP = EPDM BN = Buna-N/Nitrile/NBR
Flange Material	STL = Zinc Plated Steel 304L = 304L Stainless Steel 316L = 316L Stainless Steel
Class	150 = 150# Drilling 300 = 300# Drilling PXX = DIN PN10/PN16Drilling (available upon request)
Example	AJS0200-NE-STL-150 = Single Sphere Expansion Joint with Neoprene Body and Steel Flanges with 150# Drill Pattern

OPERATING CONDITIONS

Size Range	1" - 12"	14" - 24"
Operating Pressure	225 psi (up to 160 °F)	150 psi (up to 160 °F)
Burst Pressure	900 psi (at 70 °F)	600 psi (at 70 °F)
Vacuum Rating*	26 in/hg	15 in/hg
Operating Temp Range*	14 °F- 180 °F (Neoprene) 14 °F- 210 °F (EPDM) 14 °F- 180 °F (Buna-N/Nitrile/NBR)	

MATERIALS

Part	Part Description	Material
1	Flanges	Mild Steel - Zinc Plated steel or Stainless Steel
2	Reinforcing Wire	Mild Steel
3	Tube	Synthetic Rubber
4	Cover	Synthetic Rubber
5	Reinforcing Cord	Nylon

**** - Warnings:**

- Pressure ratings listed in the above table are for temperatures up to 160 °F. For temperature service above 160 °F, please contact API Sales for actual working pressure ratings.
- Limit rods are required in systems that are unanchored and recommended in all other applications.
- Not for use in steam applications

Single Sphere Rubber Expansion Joints - *Flange x Flange* (AJS & SAJS Series)

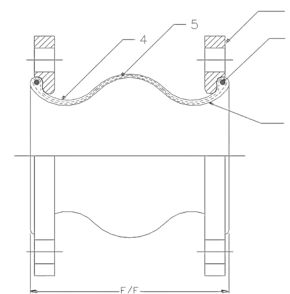

FEATURES

- Applicable for suction and delivery (discharge).
- Provides sound and vibration isolation.
- Gaskets and packing are not required.
- Floating flanges allow for easy installation.
- Prevents piping system and equipment breakdown by absorbing elongation and contraction caused by temperature variances.
- Absorbs water pulsation and minimizes water hammering.
- DIN drilled flanges available upon request (See DIN Flange section for dimensions).
- Working pressure ratings based on 4:1 safety margin (at 70 °F).

APPLICATIONS

- Pumps & air compressors in air conditioning system & sanitary equipment.
- Refrigeration systems and blowers in industrial plant equipment.
- Feed-water and drainage equipment in marine piping systems.
- Applicable for use in power generation and chemical plants.

DIMENSION & ALLOWABLE MOVEMENTS

ALL DIMENSIONS ARE IN INCHES UNLESS OTHERWISE STATED.

API Part Number	Size	Face to Face Dimensions	Allowable Motion Ratings*				Installation Tolerances			
			Compression	Elongation	Lateral	Angular	Compression	Elongation	Lateral	Angular
(S)AJS0100	1	6	0.50	0.38	0.50	20°	0.19	0.13	0.25	5°
(S)AJS0125	1.25	6	0.50	0.38	0.50	20°	0.19	0.13	0.25	5°
(S)AJS0150	1.5	6	0.50	0.38	0.50	20°	0.19	0.13	0.25	5°
(S)AJS0200	2	6	0.50	0.38	0.50	20°	0.19	0.13	0.25	5°
(S)AJS0250	2.5	6	0.50	0.38	0.50	15°	0.19	0.13	0.25	5°
(S)AJS0300	3	6	0.50	0.38	0.50	15°	0.19	0.13	0.25	5°
(S)AJS0400	4	6	0.63	0.38	0.50	15°	0.19	0.13	0.25	5°
(S)AJS0500	5	6	0.63	0.38	0.50	15°	0.19	0.13	0.25	5°
(S)AJS0600	6	6	0.63	0.38	0.50	15°	0.19	0.13	0.25	5°
(S)AJS0800	8	6	0.63	0.38	0.50	15°	0.19	0.13	0.25	5°
(S)AJS1000	10	8	0.75	0.50	0.75	15°	0.19	0.13	0.25	5°
(S)AJS1200	12	8	0.75	0.50	0.75	15°	0.19	0.13	0.25	5°
(S)AJS1400	14	8	1.00	0.63	0.75	15°	0.19	0.13	0.25	5°
(S)AJS1600	16	8	1.00	0.63	0.75	15°	0.19	0.13	0.25	5°
(S)AJS1800	18	8	1.00	0.63	0.75	15°	0.19	0.13	0.25	5°
(S)AJS2000	20	8	1.00	0.63	0.75	15°	0.19	0.13	0.25	5°
(S)AJS2400	24	10	1.00	0.63	0.75	15°	0.19	0.13	0.25	5°

Warning: Do not elongate rubber expansion joints when installing for suction service. “*” - Non Concurrent Ratings.

Notes:

- a. For all expansion joint configurations - See section 10.05

Twin Sphere Rubber Expansion Joints - *Flange x Flange* (AJT & SAJT Series)

FEATURES

- Applicable for suction and delivery (discharge).
- Designed for greater compression, elongation, and angular movement than the single sphere expansion joint.
- Excellent for absorbing thermal expansion and eliminating sound and vibration.
- Gaskets and packing not required.
- Good electrical insulator.
- Absorbs water pulsation and minimizes water hammering.
- DIN drilled flanges available upon request (See DIN Flange section for dimensions).
- Working pressure ratings based on 4:1 safety margin (at 70° F).

APPLICATIONS

- Pressure piping systems in building equipment and general industrial plants.
- Pump and turbine lines used for power generation plants, industrial machinery and universal pump blowers.
- Feed-water & drainage lines for waterworks & sanitary piping systems.
- Pipelines for industrial plants and shipbuilding yards.

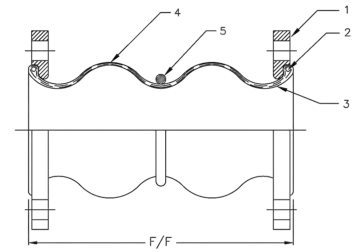

DIMENSION & ALLOWABLE MOVEMENTS

ALL DIMENSIONS ARE IN INCHES UNLESS OTHERWISE STATED.

API Part Number	Size	Face to Face Dimension	Allowable Motion Ratings**				Installation Tolerances			
			Compression	Elongation	Lateral	Angular	Compression	Elongation	Lateral	Angular
(S)AJT0100*	1	5.00	2.00	1.00	1.75	35°	0.25	0.13	0.31	10°
(S)AJT0125*	1.25	7.00	2.00	1.00	1.75	35°	0.25	0.13	0.31	10°
(S)AJT0150*	1.5	7.00	2.00	1.00	1.75	35°	0.25	0.13	0.31	10°
(S)AJT0200*	2	7.00	2.00	1.00	1.75	35°	0.25	0.13	0.31	10°
(S)AJT0250	2.5	7.00	2.00	1.00	1.75	35°	0.25	0.13	0.31	10°
(S)AJT0300	3	7.00	2.00	1.00	1.75	35°	0.25	0.13	0.31	10°
(S)AJT0400	4	9.00	2.00	1.38	1.56	35°	0.25	0.13	0.31	10°
(S)AJT0500	5	9.00	2.00	1.38	1.56	30°	0.25	0.13	0.38	10°
(S)AJT0600	6	9.00	2.38	1.38	1.56	30°	0.25	0.13	0.38	10°
(S)AJT0800	8	13.00	2.38	1.50	1.38	30°	0.25	0.13	0.50	10°
(S)AJT1000	10	13.00	2.38	1.50	1.38	30°	0.25	0.13	0.50	10°
(S)AJT1200	12	13.00	2.38	1.50	1.38	20°	0.25	0.13	0.50	10°
(S)AJT1400	14	13.75	2.38	1.50	1.13	20°	0.25	0.13	0.31	10°
(S)AJT1600	16	13.75	2.38	1.50	1.13	20°	0.25	0.13	0.31	10°
(S)AJT1800	18	13.75	2.38	1.50	1.13	20°	0.25	0.13	0.31	10°
(S)AJT2000	20	13.75	2.38	1.50	1.13	20°	0.25	0.13	0.31	10°
(S)AJT2400	24	13.75	2.38	1.50	1.13	20°	0.25	0.13	0.31	10°

Warning: Do not elongate rubber expansion joints when installing for suction service.

** - Sizes ≤ 2" do not have root rings.

*** - Non Concurrent Ratings.

Notes:

- a. For all expansion joint configurations - See section 10.05

Twin Sphere Rubber Expansion Joints - *Union x Union*

FEATURES

- Efficient noise and vibration isolation.
- Ability to absorb large displacement due to eccentric, axial, and angular movement.
- Applicable for both suction and discharge.
- Female Threaded Unions allow for easy installation.

APPLICATIONS

- Vibration isolation for small pumps and circular pumps.
- Sewage disposal purifier line.
- Vibration isolation for air-conditioners and pipes.

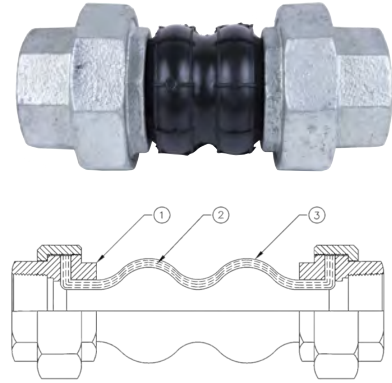

DIMENSION & ALLOWABLE MOVEMENTS

ALL DIMENSIONS ARE IN INCHES UNLESS OTHERWISE STATED.

API Part Number	Size	Face to Face dimension (L)	Allowable Motion Ratings				Approximate Weight (lbs)
			Compression	Elongation	Lateral	Angular	
AMU0050-XX	0.5	8.00	0.88	0.25	0.88	45°	1.5
AMU0075-XX	0.75	8.00	0.88	0.25	0.88	45°	1.8
AMU0100-XX	1	8.00	0.88	0.25	0.88	45°	2.8
AMU0125-XX	1.25	8.00	0.88	0.25	0.88	45°	3.5
AMU0150-XX	1.5	8.00	0.88	0.25	0.88	45°	4.0
AMU0200-XX	2	8.00	0.88	0.25	0.88	45°	5.0

Warning: Do not elongate rubber expansion joints when installing for suction service. “**” - Non Concurrent Ratings.

PART NUMBER STRUCTURE

Part Number Section	Options
Type	AMU = Twin Sphere Union Expansion Joint
Size	XXXX = Size in inches going out 2 decimal places
Body Material *Denoted with "XX"	EP = EPDM NE = Neoprene

OPERATING CONDITIONS

Operating Pressure	up to 150 psi
Normal Operating Temp.	14° - 158° F
Vacuum Rating	25" Hg
Burst Pressure	750 psi

MATERIALS

Part	Part Description	Material
1	Threaded Union	Malleable Iron (Hot Dipped Galv.)
2	Reinforcing Cloth	Nylon Fabric
3	Elastomer	EPDM

“**” - Warning:

Pressure ratings listed in the above table are for up to 110 °F (for Neoprene), and 125 °F (for EPDM). For elevated temperature service, please contact API Sales for actual working pressure ratings.

Control Units - Mild Steel (Zinc Plated)**



ALL DIMENSIONS ARE IN INCHES UNLESS OTHERWISE STATED.

Complete unit* API Part Number	Size	Expansion Joint Application	Gusset Plate Part Number	Plate THK.	Plate Weight (lbs)	Control ROD Part Number***	Approximate Weight (lbs)
CRU0150	1.5	SINGLE/TWIN	CRP0150	0.50	0.8	CR0625-14S	6.4
CRU0200	2	SINGLE/TWIN	CRP0200	0.50	1.0	CR0625-14S	7.2
CRU0250	2.5	SINGLE/TWIN	CRP0250	0.50	1.3	CR0625-14S	8.4
CRU0300	3	SINGLE/TWIN	CRP0300	0.50	1.6	CR0625-14S	9.6
CRUS0400	4	SINGLE	CRP0400	0.50	1.4	CR0625-14S	8.8
CRUT0400	4	TWIN	CRP0400	0.50	1.4	CR0625-17T	9.2
CRUS0500	5	SINGLE	CRP0500	0.50	1.5	CR0625-14S	9.2
CRUT0500	5	TWIN	CRP0500	0.50	1.5	CR0625-17T	9.6
CRUS0600	6	SINGLE	CRP0600	0.50	1.7	CR0625-14S	10.0
CRUT0600	6	TWIN	CRP0600	0.50	1.7	CR0625-17T	10.4
CRUS0800	8	SINGLE	CRP0800	0.50	2.1	CR0875-18S	16.4
CRUT0800	8	TWIN	CRP0800	0.50	2.1	CR0875-23T	17.6
CRUS1000	10	SINGLE	CRP1000	0.75	3.5	CR0875-18S	22.0
CRUT1000	10	TWIN	CRP1000	0.75	3.5	CR0875-23T	23.2
CRUS1200	12	SINGLE	CRP1200	0.75	5.0	CR1125-18S	34.0
CRUT1200	12	TWIN	CRP1200	0.75	5.0	CR1125-23T	36.0
CRUS1400	14	SINGLE	CRP1416	0.75	5.0	CR1125-18S	34.0
CRUT1400	14	TWIN	CRP1416	0.75	5.0	CR1125-23T	36.0
CRUS1600	16	SINGLE	CRP1416	0.75	5.0	CR1125-18S	34.0
CRUT1600	16	TWIN	CRP1416	0.75	5.0	CR1125-23T	36.0
CRUS1800	18	SINGLE	CRP1820	0.75	6.0	CR1125-18S	38.0
CRUT1800	18	TWIN	CRP1820	0.75	6.0	CR1125-23T	40.0
CRUS2000	20	SINGLE	CRP1820	0.75	6.0	CR1125-18S	38.0
CRUT2000	20	TWIN	CRP1820	0.75	6.0	CR1125-23T	40.0
CRUS2400	24	SINGLE	CRP2400	1.00	7.5	CR1250-18S	47.0
CRUT2400	24	TWIN	CRP2400	1.00	7.5	CR1250-23T	49.0

Warning: Do not elongate expansion joints when installing for suction service.

** - Complete units consist of the following: 2 Rods; 4 Plates; 8 Nuts; 8 Steel Washers; & 8 Neoprene Washers.

If needed, 3 or more rod sets are available upon request.

*** - Sets are also available in 304/316 Stainless Steel.

**** - Single (S); Twin (T).

a. Available in ANSI Class 150 and 300 drilling pattern

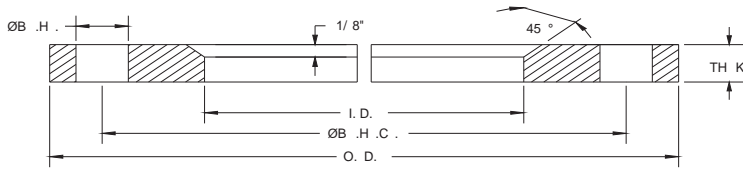

Split Retaining Rings - Class 150 Drill Pattern

API Part Number	Size	O.D.	I.D.	Ø B.H.C.	Ø B.H	# B.H	THK	Set Weight (lbs.)
(S)RR0050	0.5	3.50	1.50	2.38	0.630	4	0.375	1.57
(S)RR0075	0.75	3.88	1.88	2.75	0.630	4	0.375	1.85
(S)RR0100	1	4.25	2.38	3.13	0.630	4	0.375	2.02
(S)RR0125	1.25	4.63	2.63	3.50	0.630	4	0.375	2.41
(S)RR0150	1.5	5.00	2.88	3.88	0.630	4	0.375	2.82
(S)RR0200	2	6.00	3.63	4.75	0.750	4	0.375	3.83
(S)RR0250	2.5	7.00	4.13	5.50	0.750	4	0.375	5.53
(S)RR0300	3	7.50	4.63	6.00	0.750	4	0.375	6.06
(S)RR0400	4	9.00	5.88	7.50	0.750	8	0.375	7.81
(S)RR0500	5	10.00	6.88	8.50	0.880	8	0.375	8.65
(S)RR0600	6	11.00	7.88	9.50	0.880	8	0.375	9.81
(S)RR0800	8	13.50	9.88	11.75	0.880	8	0.375	14.60
(S)RR1000	10	16.00	12.13	14.25	1.000	12	0.375	18.03
(S)RR1200	12	19.00	14.50	17.00	1.000	12	0.375	25.83
(S)RR1400	14	21.00	16.50	18.75	1.130	12	0.375	28.56
(S)RR1600	16	23.50	18.50	21.25	1.130	16	0.375	35.29
(S)RR1800	18	25.00	20.50	22.75	1.250	16	0.375	33.46
(S)RR2000	20	27.50	22.63	25.00	1.250	20	0.375	39.63
(S)RR2200	22	29.50	24.63	27.25	1.380	20	0.375	41.98
(S)RR2400	24	32.00	26.63	29.50	1.380	20	0.375	51.51
(S)RR2600	26	34.25	28.88	31.75	1.380	24	0.375	54.60
(S)RR2800	28	36.50	30.88	34.00	1.380	28	0.375	60.56
(S)RR3000	30	38.75	32.88	36.00	1.380	28	0.375	68.34
(S)RR3200	32	41.75	34.88	38.50	1.630	28	0.375	84.14
(S)RR3400	34	43.75	37.00	40.50	1.630	32	0.375	85.63
(S)RR3600	36	46.00	39.00	42.75	1.630	32	0.375	94.93
(S)RR4000	40	50.75	43.00	47.25	1.630	36	0.375	117.44
(S)RR4200	42	53.00	45.25	49.50	1.630	36	0.375	123.93
(S)RR4400	44	55.25	47.25	51.75	1.630	40	0.375	132.85
(S)RR4800	48	59.50	51.25	56.00	1.630	44	0.375	148.31
(S)RR5000	50	61.75	53.25	58.25	1.880	44	0.375	153.01
(S)RR5200	52	64.00	55.25	60.50	1.880	44	0.375	165.28
(S)RR5400	54	66.25	57.25	62.75	2.000	44	0.375	177.95

1 Set = 4 Split Ring Halves (thru 28") and 8 Split Ring Quarters (for 30" or greater)

Notes:

- a. Available in are Silver Zinc Plated Steel, Standard Grade 304 and Dual Grade 316/316L Stainless Steel.
- b. Navy or DIN drilling available on special order basis.

ALL DIMENSIONS ARE IN INCHES UNLESS OTHERWISE STATED.

PART NUMBER STRUCTURE

Part Number Section	Options
Type	RR = Zinc Plated Steel SRR = Stainless Steel
Size	XXXX = Size in inches going out 2 decimal places
Material	4= Standard Grade 304 Stainless Steel 16L = Dual Grade 316/316L Stainless Steel
Other	S = Set
Example	SRR2000-16L-S

DC# 1224

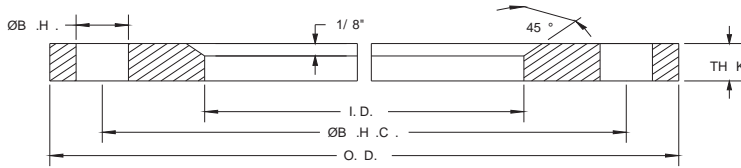

Split Retaining Rings - Class 300 Drill Pattern (Zinc Plated Steel)

API Part Number	Size	O.D.	I.D.	Ø B.H.C.	Ø B.H.	# B.H	THK	Set Weight (lbs.)
RR0100-30	1	4.88	2.38	3.50	0.750	4	0.375	2.69
RR0125-30	1.25	5.20	2.63	3.88	0.750	4	0.375	3.00
RR0150-30	1.5	6.13	2.88	4.50	0.880	4	0.375	4.43
RR0200-30	2	6.50	3.63	5.00	0.880	8	0.375	3.80
RR0250-30	2.5	7.50	4.13	5.88	0.880	8	0.375	5.48
RR0300-30	3	8.25	4.63	6.63	0.880	8	0.375	6.71
RR0400-30	4	10.00	5.88	7.88	0.880	8	0.375	9.83
RR0500-30	5	11.00	6.88	9.25	0.880	8	0.375	11.20
RR0600-30	6	12.50	7.88	10.63	0.880	12	0.375	14.09
RR0800-30	8	15.00	9.88	13.00	1.000	12	0.375	19.15
RR1000-30	10	17.50	12.13	15.25	1.130	16	0.375	23.02
RR1200-30	12	20.50	14.50	17.75	1.250	16	0.375	30.71
RR1400-30	14	23.00	16.50	20.25	1.250	20	0.375	37.43
RR1600-30	16	25.50	18.50	22.50	1.250	20	0.375	45.94
RR1800-30	18	28.00	20.50	24.75	1.250	24	0.375	54.15
RR2000-30	20	30.50	22.63	27.00	1.250	24	0.375	63.18
RR2400-30	24	36.00	26.63	32.00	1.500	24	0.375	88.45

1 Set = 4 Split Ring Halves.

Notes:

- a. Rings are Steel & Silver Zinc Plated.
- b. Navy or DIN drilling available on special order basis.

ALL DIMENSIONS ARE IN INCHES UNLESS OTHERWISE STATED.

Pump Connectors



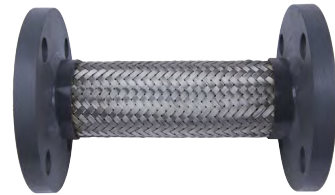
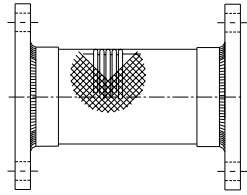

Stainless Steel Braided - Flanged Pump Connectors

API Part Number	Size	Overall Length	Operating Pressure (PSI)		Flange Thickness	Approx. Weight (lbs)
			At 70° F.	At 250° F.		
PCF0200-SSB	2	9.0	300	276	0.625	11.0
PCF0250-SSB	2.5	9.0	350	322	0.625	14.0
PCF0300-SSB	3	9.0	300	276	0.625	15.0
PCF0400-SSB	4	9.0	250	230	0.625	20.0
PCF0500-SSB	5	11.0	175	161	0.750	28.0
PCF0600-SSB	6	11.0	165	152	0.750	33.0
PCF0800-SSB	8	12.0	150	138	1.000	51.0
PCF0800-SBB	8	12.0	174	160	1.000	52.0
PCF1000-SSB	10	13.0	140	129	1.000	73.0
PCF1000-SBB	10	13.0	180	165	1.000	74.0
PCF1200-SSB	12	14.0	130	119	1.000	100.0
PCF1400-SSB	14	14.0	125	115	1.000	108.0

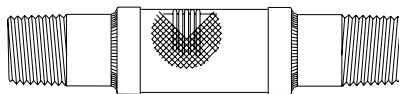

Stainless Steel Braided - Threaded Pump Connectors

API Part Number	Size	Overall Length	Operating Pressure (PSI)		Approx. Weight (Lbs)
			At 70° F.	At 250° F.	
PCT0050-SSB	0.5	6.5	825	760	0.5
PCT0075-SSB	0.75	7.0	487	448	0.8
PCT0100-SSB	1	8.0	475	437	1.0
PCT0125-SSB	1.25	8.5	425	391	1.5
PCT0150-SSB	1.5	9.0	425	391	2.0
PCT0200-SSB	2	10.5	300	276	2.5
PCT0250-SSB	2.5	12.0	350	322	3.0
PCT0300-SSB	3	14.0	300	276	5.0
PCT0400-SSB	4	16.0	250	230	8.0

Notes:

- a. Pump Connectors are designed to absorb pump vibration, plus 1/8" misalignment.
- b. Working pressures are based on simple pump vibration in a static installation and may vary based on specific application.
- c. Threads on PCT series Pump Connectors are Male x Male NPT.
- d. For elevated temperature service (above 250°F.) please contact API Sales for actual working pressure ratings.
- e. All flanged Pump Connectors have a 150# drilling pattern.

ALL DIMENSIONS ARE IN INCHES UNLESS OTHERWISE STATED.

Part	Material
Hose	300 Series Stainless Steel
Braid	300 Series Stainless Steel
Collar	300 Series Stainless Steel
Flange or Threaded End	Steel

PART NUMBER STRUCTURE

Part Number Section	Options
Type	PCF = Flanged Pump Connector PCT = Threaded Pump Connector
Size	XXXX = Size in inches going out 2 decimal places
Braid Type	SSB = Single Standard Braid SBB = Single Braided Braid

Fittings & Accessories



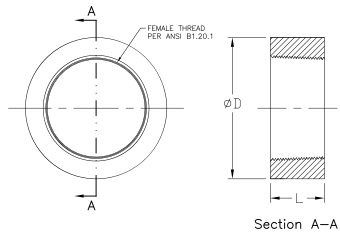

Half Couplings

O.D. TUBE SIZES

API Part Number	Nominal Pipe Size (inches)	OD	End to End Length	Threads per Inch
THC0025	0.25	0.710	0.57	18.0
THC0050	0.5	1.060	0.75	14.0
THC0075	0.75	1.310	0.81	14.0
THC0100	1	1.570	1.00	11.5
THC0125	1.25	1.900	1.00	11.5
THC0150	1.5	2.200	1.00	11.5
THC0200	2	2.750	1.06	11.5
THC0250	2.5	3.250	1.06	8.0
THC0300	3	4.000	1.63	8.0
THC0400	4	5.000	1.75	8.0
THC0500	5	6.290	1.90	8.0
THC0600	6	7.390	2.00	8.0
THC0800	8	9.610	2.63	8.0

Notes:

- a. Coupling material is mild steel.
- b. Threads conform to ANSI B1.20.1.

ALL DIMENSIONS ARE IN INCHES UNLESS OTHERWISE STATED.

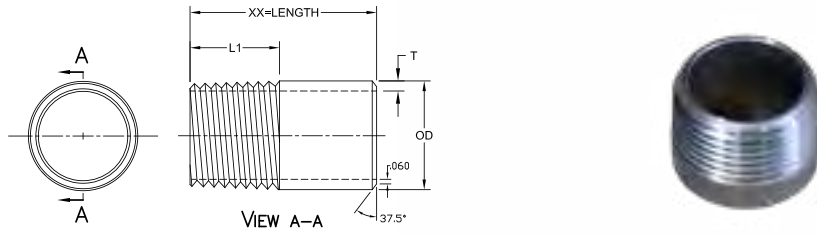

Thread One End Nipples

O.D. TUBE SIZES

API Part Number	Nominal Pipe Size (inches)	OD	End to End Length	Threads Per Inch	Min. Thread Length	Min. Wall Thickness
TOE0075-1.0	0.75	1.050	1.00	14.0	0.65	0.113
TOE0075-3.0	0.75	1.050	3.00	14.0	0.65	0.113
TOE0100-1.0	1	1.315	1.00	11.5	0.65	0.133
TOE0100-3.0	1	1.315	3.00	11.5	0.65	0.133
TOE0125-1.5	1.25	1.660	1.50	11.5	0.93	0.140
TOE0125-3.0	1.25	1.660	3.00	11.5	0.93	0.140
TOE0200-2.0	2	2.375	2.00	11.5	1.10	0.154
TOE0200-3.0	2	2.375	3.00	11.5	1.10	0.154
TOE0250-2.0	2.5	2.875	2.00	8.0	1.30	0.203
TOE0300-3.0	3	3.500	3.00	8.0	1.65	0.216
TOE0300-4.0	3	3.500	4.00	8.0	1.65	0.216
TOE0400-4.0	4	4.500	4.00	8.0	1.75	0.237
TOE0500-4.0	5	5.563	4.00	8.0	1.85	0.258
TOE0600-4.0	6	6.625	4.00	8.0	2.00	0.280
TOE0600-4.5	6	6.625	4.50	8.0	2.00	0.280
TOE0600-6.0	6	6.625	6.00	8.0	2.00	0.280
TOE0800-4.0	8	8.625	4.00	8.0	2.15	0.322
TOE0800-6.0	8	8.625	6.00	8.0	2.15	0.322

Notes:

- a. Nipple material is mild steel.
- b. NPT threads in accordance with ANSI B2.1.

ALL DIMENSIONS ARE IN INCHES UNLESS OTHERWISE STATED.

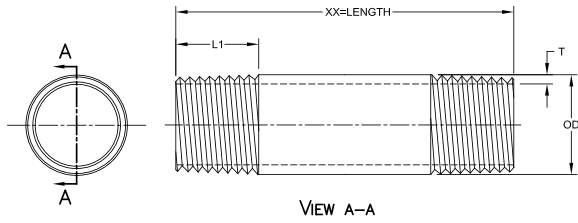

Threaded Both End Nipples

O.D. TUBE SIZES

API Part Number	Nominal Pipe Size (inches)	OD	End to End Length	Threads per Inch	Min. Thread Length	Min. Wall Thickness
TBE0075-1.38	0.75	1.050	1.38	14.0	0.75	0.113
TBE0075-2.0	0.75	1.050	2.00	14.0	0.75	0.113
TBE0075-3.0	0.75	1.050	3.00	14.0	0.75	0.113
TBE0100-4.0	1	1.315	4.00	11.5	1.00	0.133
TBE0100-12.0	1	1.315	12.00	11.5	1.00	0.133
TBE0250-6.0	2.5	2.875	6.00	8.0	1.60	0.209
TBE0400-8.0	4	4.500	8.00	8.0	1.75	0.237

Notes:

- a. Nipple material is mild steel.
- b. NPT threads in accordance with ANSI B2.1.

ALL DIMENSIONS ARE IN INCHES UNLESS OTHERWISE STATED.

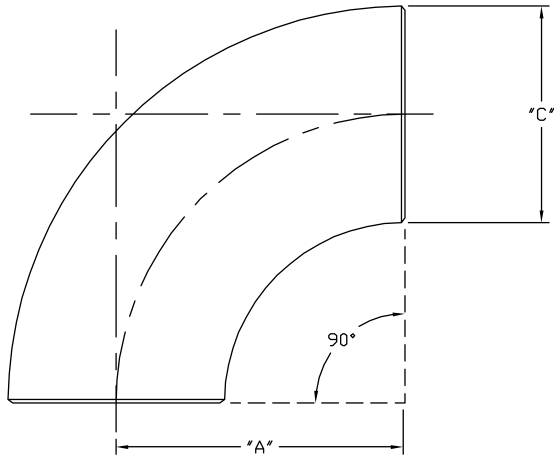

LONG RADIUS 90°

Long Radius 304L Stainless Steel 90° Elbows (LRE Series)

DIMENSIONS

API Part Number	NOM. PIPE SIZE	OUTSIDE DIAMETER (O.D)	CENTER TO END (C to E)	INSIDE DIAMETER (I.D)	WALL THICKNESS (T)
LRE0100-90	1	1.315	1.500	1.097	0.109
LRE0125-90	1.25	1.660	1.875	1.442	0.109
LRE0150-90	1.5	1.900	2.250	1.682	0.109
LRE0200-90	2	2.375	3.000	2.157	0.109
LRE0250-90	2.5	2.875	3.750	2.635	0.120
LRE0300-90	3	3.500	4.500	3.260	0.120
LRE0400-90	4	4.500	6.000	4.260	0.120
LRE0500-90	5	5.563	7.500	5.295	0.134
LRE0600-90	6	6.625	9.000	6.357	0.134
LRE0800-90	8	8.625	12.000	8.329	0.148
LRE1000-90	10	10.750	15.000	10.420	0.165
LRE1200-90	12	12.750	18.000	12.390	0.180

- ANSI B16.9
- MSS SP-43
- Schedule 10S

ALL DIMENSIONS ARE IN INCHES UNLESS OTHERWISE STATED.

MATERIALS

- ASTM A403
- WP304
- WP304H
- WP304L
- WP316
- WP316L



Gaskets

API stocks a variety of sizes of full face and ring gaskets in green Non-Asbestos (GNA Series) and SBR (GRR Series) materials.

Nominal Pipe Size I.D. (old style)	ANSI Size I.D. (newstyle)	Full Face Gaskets - (125/150#)				Full Face Gaskets - (250/300#)				Ring Gaskets	
		O.D	# B.H	Ø B.H.	Ø B.H.C.	O.D	# B.H	Ø B. H.	Ø B.H. C.	125/150# (OD)	250/300# (OD)
0.5	0.878	3.50	4	0.625	2.375	3.750	4	0.625	2.625	1.875	2.125
0.75	1.062	3.88	4	0.625	2.750	4.625	4	0.750	3.250	2.250	2.625
1	1.313	4.25	4	0.625	3.125	4.875	4	0.750	3.500	2.625	2.875
1.25	1.683	4.63	4	0.625	3.500	5.250	4	0.750	3.875	3.000	3.250
1.5	1.943	5.00	4	0.625	3.875	6.125	4	0.875	4.500	3.375	3.750
2	2.375	6.00	4	0.750	4.750	6.500	8	0.875	5.000	4.125	4.375
2.5	2.875	7.00	4	0.750	5.500	7.500	8	0.875	5.875	4.875	5.125
3	3.500	7.50	4	0.750	6.000	8.250	8	0.875	6.625	5.375	5.875
3.5	4.000	8.50	8	0.750	7.000	9.000	8	0.875	7.250	6.375	6.500
4	4.500	9.00	8	0.750	7.500	10.00	8	0.875	7.875	6.875	7.125
5	5.563	10.00	8	0.875	8.500	11.00	8	0.875	9.250	7.750	8.500
6	6.625	11.00	8	0.875	9.500	12.50	12	0.875	10.63	8.750	9.875
8	8.650	13.50	8	0.875	11.75	15.00	12	1.000	13.00	11.000	12.125
10	10.750	16.00	12	1.000	14.25	17.50	16	1.125	15.25	13.380	14.250
12	12.750	19.00	12	1.000	17.00	20.50	16	1.250	17.75	16.130	16.625
14	14.000	21.00	12	1.125	18.75	23.00	20	1.250	20.25	17.750	19.125
16	16.000	23.50	16	1.125	21.25	25.50	20	1.375	22.50	20.500	21.250
18	18.000	25.00	16	1.250	22.75	28.00	24	1.375	24.75	21.630	23.500
20	20.000	27.50	20	1.250	25.00	30.50	24	1.375	27.00	23.880	25.750
22	22.000	29.50	20	1.375	27.25	33.00	24	1.625	29.25	26.000	27.625
24	24.000	32.00	20	1.375	29.50	36.00	24	1.625	32.00	28.250	30.500
26	26.000	34.75	24	1.375	31.75	38.25	28	1.750	34.50	30.500	32.875
28	28.000	36.50	28	1.375	34.00	40.75	28	1.750	37.00	32.750	35.375
30	30.000	38.75	28	1.375	36.00	43.00	28	1.875	39.50	34.750	37.500
32	32.000	41.75	28	1.625	38.50	45.25	28	2.000	41.50	38.000	39.625
34	34.000	43.75	32	1.625	40.50	47.50	28	2.000	43.50	39.000	41.625
36	36.000	46.00	32	1.625	42.75	50.00	32	2.125	46.00	41.250	44.000
38	38.000	48.75	36	1.625	45.25	52.25	32	2.250	48.00	43.630	46.125
40	40.000	50.75	36	1.625	47.25	54.25	36	2.250	50.25	45.630	48.750
42	42.000	53.00	36	1.625	49.50	57.00	36	2.250	52.75	48.000	50.750
44	44.000	55.25	40	1.625	51.75	59.25	36	2.250	55.00	50.130	53.000
46	46.000	57.25	40	1.625	53.75	61.50	40	2.250	57.75	52.130	55.250
48	48.000	59.50	44	1.625	56.00	65.00	40	2.250	60.75	54.500	58.500

Note:

- Dimensions per ANSI B 16.5 and AWWA C110 standards for pipe flanges and gaskets.
- Dimensional tolerances (unless otherwise stated): Up to 1" @ +/- .0325"; 1.25" thru 12" @ +/- .0625"; 14" thru 24" @ +/- .0975"; 24" and above @ +/- .25".
- Standard gasket material is SBR (Red Rubber) or Non-Asbestos (Green), but Neoprene, EPDM, Buna N, Silicone, Viton Teflon and other compounds are readily available.
- Standard thicknesses are 1/16" and 1/8", but other thickness are available.
- Sizes above 24" available upon request (minimum order quantity may apply).

ALL DIMENSIONS ARE IN INCHES UNLESS OTHERWISE STATED.

Gaskets - Basic Compounds & Properties

				General Chemical Resistance	
Common Name (s)	Designation	Composition	General Properties	Resistance to	Attacked by:
Neoprene	CR	Chloroprene	Good weathering resistance and flame retarding. Good resistance to petroleum based fluids.	Moderate chemicals and acids, ozone, oils, fats, greases and many solvents.	Strong oxidizing acids, esters, ketones, chlorinated, aromatic and nitro hydrocarbons.
EPDM	EPM	Ethylene-propylene-diene-molimers	Excellent ozone, chemical and aging resistance. Excellent heat resistance. Poor resistance to petroleum based fluids.	Heat, ozone, strong oxidizing chemicals and acetone.	Petroleum based fluids, animal fats, solvents and greases.
Buna-N	NBR	Nitrile-butadiene	Excellent resistance to petroleum based fluids. Good physical properties.	Many hydrocarbons, fats, oils, hydraulic fluids and chemicals.	Ozone (except PVC blends), ketones, esters, aldehydes, chlorinated and nitro hydrocarbons.
Silicones	Q, Si	Polysiloxane	Excellent high and low temperature properties. Good oil resistance. FDA compound. Good physical properties.	Moderate chemicals and acids, ozone, oils, fats, greases and concentrated sodium hydroxide.	Many solvents, high aromatic hydrocarbons, concentrated acids, dilute sodium hydroxide.
SBR (Red Rubber)	SBR	Styrene-butadiene	Good physical properties and abrasion resistance. Poor resistance to petroleum based fluids.	Most moderate chemicals wet or dry, organic acids, alcohols, ketones and aldehydes.	Ozone, strong acids, animal fats, oils, greases and most hydrocarbons.
Viton (Fluoro-elastomer)	FPM	Hexafluoropropylene-vinylidene fluoride	Excellent oil and air resistance at low and high temperatures. Excellent chemical resistance.	All aliphatic, aromatic and halogenated hydrocarbons, acids, animal and vegetable oils.	Ketones, low molecular weight esters and nitro containing compounds
Teflon® (Fluorocarbon resin)	TFE	Polytetra-fluoroethylene	Excellent chemical and solvent resistance. Resistant to very high temperatures.	Inert to most chemicals, smooth anti-adhesive surface. Easily cleaned.	Acetates, NA-K and some amino acids.
Non-Asbestos	NA	Aramid fiber and synthetic fibers bonded with NBR.	General service water & oil gasket. Pressures to 1595 psi, Temp to 750o F.	Mild acids, Alkalis, Oils, general chemicals & petroleum derivatives and steam.	Consult customer service for chemical compatibility.

Notes:

- The chemical guidelines in this table are offered as a general indication of the compatibility of various materials with chemicals and fluids listed.
- When in doubt a sample of the compound should always be tested with the particular chemical it is to handle.
- API stocks Non-Asbestos (GNA Series) and SBR (GRR Series) gaskets, but others are available upon request (minimum order quantity may apply).

PART NUMBER STRUCTURE

Part Number Section	Options
Material	GNA = Green Non-Asbestos GRR = Red Rubber
Size	XXXX = Size in inches going out 2 decimal places
Type	FF = Full Face R = Ring
Thickness	XXX = Size in inches going out 3 decimal places

DC# 0524

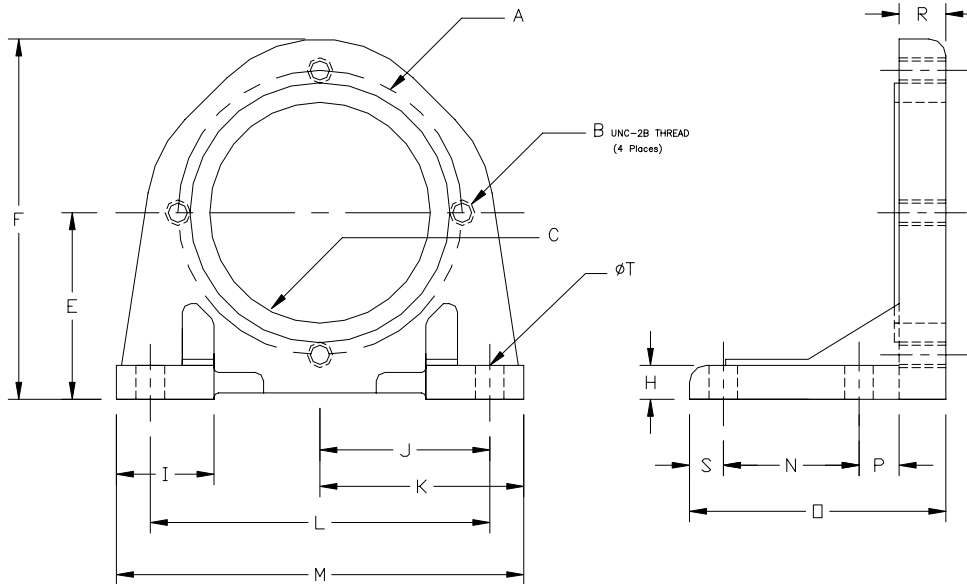

Hydraulic Motor Pump Brackets

DIMENSIONS

API Part Number	A	B	C	E	F	H	I	J	K	L	M	N	O	P	R	S	T	Weight (lbs)
HB-A	4.19	.38-16	3.25	2.75	5.31	0.50	1.44	2.50	3.00	5.00	6.00	2.00	3.78	0.59	0.69	0.50	0.43	4
HB-B	5.75	.50-13	4.00	3.63	7.12	0.50	1.44	2.88	3.38	5.75	6.75	2.00	3.77	0.59	0.69	0.50	0.43	5
HB-C	7.13	.62-11	5.00	4.31	8.50	0.62	2.00	4.63	5.22	9.25	10.44	3.00	5.18	0.75	0.75	0.68	0.69	12

ALL DIMENSIONS ARE IN INCHES UNLESS OTHERWISE STATED.

MATERIALS

Part	Material
Body	Cast Iron



Notes:

SAE-J744, 3 sizes for the same specification for Gear Pump, Vickers Piston Pump, or Vane Pump & Motors.

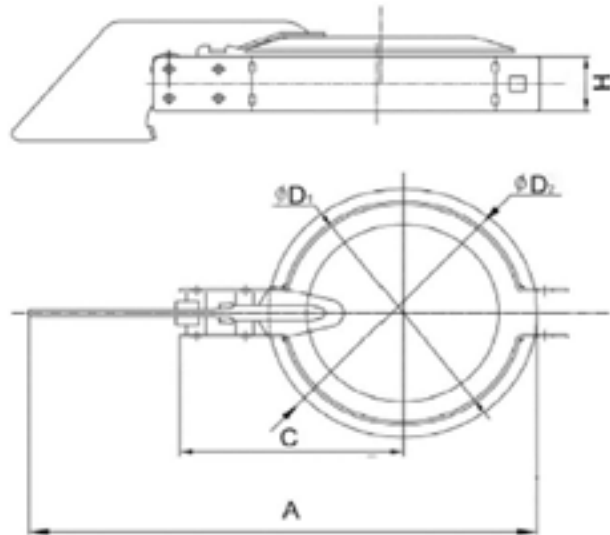

Exhaust Rain Caps

DIMENSIONS

API Part Number	Size	"A"	"C"	"H"	"D1"	"D2"
RC0100-x	1	5.63	2.91	1.26	1.14	1.57
RC0150-x	1.5	5.98	2.95	1.26	1.50	1.65
RC0200-x	2	6.69	3.19	1.26	2.03	2.52
RC0250-x	2.5	7.17	3.46	1.26	2.52	2.99
RC0300-x	3	7.68	3.74	1.26	3.01	3.50
RC0350-x	3.5	8.19	3.94	1.26	3.52	4.02
RC0400-x	4	9.61	4.27	1.26	4.02	4.72
RC0450-x	4.5	10.43	4.61	1.26	4.50	5.31
RC0500-x	5	10.81	4.78	1.26	5.02	5.75
RC0550-x	5.5	11.30	5.20	1.26	5.63	6.26
RC0600-x	6	11.61	5.31	1.26	5.98	6.69
RC0650-x	6.5	12.36	5.71	1.26	6.61	7.64
RC0800-x	8	13.78	6.30	1.26	7.99	8.66

"x" = **G** (Electro-Galvanized/Zink-Plated Q235 Steel)
S (304 Stainless Steel)

TEMPERATURE RATINGS

Electro-Galvanized/ Zink-Plated Q235 Steel	750° F
304 Stainless Steel	1100° F

APPLICATIONS

- Used to prevent dirt, dust, rain and other debris from falling into exposed stack pipes

Notes:

- Rain Caps rated for 2,000,000 cycles.

KLAMP[®]z

Grooved Piping System



KLAMP^z

Grooved Piping System



AVAILABLE IN:
 • UL/FM APPROVED
 • NON-UL/FM VERSIONS

Quick Reference Part Number

SHURJOINT	ANVIL	VICTAULIC									
#K05 1t Weight Flexible Coupling			#K10 90 Degree Elbow			#K11 45 Degree Elbow			#K20 Straight Tee		
											
7705	C3	75	7110	7050	10	7111	7051	11	7120	7060	20
#K41 Flange Adapter			#K58 Adapter Nipples			#K60 Cap			#KGE EPDM Gaskets		
											
7141	7012	741	58	7082	42	7160	7074	60			
#KTB ASTM A183 Track Head Bolts											
											



KLAMPz On... Stayz On!

Grooved Piping System

PIPE SIZE		PIPE SCHEDULE													
NOMINAL (in)	OD (in)	5	10	20	30	40	STD	60	80	XH	100	120	140	160	XXH
0.125	0.405	.035 .14	.049 .19			.068 .24	.068 .24		.095 .31	.095 .31					
0.25	0.504	.049 .26	.065 .33			.088 .43	.088 .43		.119 .54	.119 .54					
0.375	0.675	.049 .33	.065 .42			.091 .57	.091 .57		.126 .74	.126 .74					
0.5	0.840	.065 .54	.083 .67			.109 .85	.109 .85		.147 1.09	.147 1.09				.187 1.31	.294 1.72
0.75	1.050	.065 .68	.083 .86			.113 1.13	.113 1.13		.154 1.48	.154 1.48				.218 1.94	.308 2.44
1	1.315	.065 .87	.109 1.41			.133 1.68	.133 1.68		.179 2.17	.179 2.17				.250 2.85	.358 3.66
1.25	1.660	.065 1.11	.109 1.81			.140 2.27	.140 2.27		.191 3.00	.191 3.00				.250 3.77	.382 5.22
1.5	1.900	.065 1.27	.109 2.09			.145 2.72	.145 2.72		.200 3.63	2.00 3.63				.281 4.86	.400 6.41
2	2.375	.065 1.60	.109 2.64			.154 3.66	.154 3.66		.218 5.03	.218 5.03				.344 7.45	.436 9.04
2.5	2.875	.083 2.48	.120 3.53			.203 5.80	.203 5.80		.276 7.67	.276 7.67				.375 10.02	.552 13.71
3	3.50	.083 3.03	.120 4.34			.216 7.58	.216 7.58		.300 10.26	.300 10.26				.438 14.31	0.600 18.60
3.5	4.00	.083 3.48	.120 4.98			.226 9.12	.226 9.12		.318 12.52	.318 12.52					.636 22.87
4	4.50	.083 3.92	.120 5.62			.237 10.80	.237 10.80		.337 15.00	.337 15.00		4.38 19.02		.531 22.53	.674 27.57
5	5.56	.109 6.63	.134 7.78			.258 14.63	.258 14.63		.375 20.80	.375 20.80		.500 27.06		.625 32.99	.750 38.59
6	6.63	.109 7.59	.134 9.30		.250 17.04	.280 18.99	.280 18.99		.432 28.00	.432 28.00		.562 36.43		.718 45.39	.864 53.21
8	8.63	.109 9.92	.148 13.41	.250 22.38	.277 24.72	.322 28.58	.322 28.58	.406 35.67	.500 43.43	.500 43.43	.594 50.91	.719 60.77	.812 67.82	.906 74.76	.875 72.49
10	10.75	.134 15.21	.165 18.67	.250 28.06	.307 34.27	.365 40.52	.365 40.52	.500 54.79	.594 64.39	.500 54.79	.718 77.10	.844 89.28	1.000 104.23	1.125 115.75	1.000 104.23
12	12.75	.165 22.20	.180 24.19	.250 33.41	.330 43.81	.406 53.37	.375 49.61	.562 73.22	.688 88.71	.500 65.48	.844 107.42	1.000 125.61	1.125 139.81	1.312 164.42	1.000 125.61
14	14.00		.250 36.75	.312 45.65	.375 54.62	.438 63.50	.375 54.62	.593 84.99	.750 103.23	.500 72.16	.938 130.98	1.094 150.81	1.250 170.37	1.406 189.29	
16	16.00		.250 42.09	.312 52.32	.375 62.65	.500 82.85	.375 62.65	.656 107.60	.844 136.59	.500 82.85	1.031 164.98	1.219 192.47	1.438 223.71	1.594 245.34	
18	18.00		.250 47.44	.312 58.99	.437 82.23	.562 104.76	.375 70.65	.750 138.30	.938 171.08	.500 93.45	1.156 208.15	1.375 244.37	1.562 274.48	1.781 308.79	
20	20.00		.250 52.78	.375 78.67	.500 104.23	.594 123.02	.375 78.67	.812 166.56	1.031 209.06	.500 104.23	1.281 256.15	1.500 296.65	1.750 341.41	1.969 379.36	
22	22.00		.250 58.13	.375 86.69	.500 114.92		.375 86.69	.875 197.60	1.125 251.05	.500 114.92	1.375 303.16	1.625 353.94	1.875 403.38	2.125 451.49	
24	24.00		.250 63.47	.375 94.71	.562 140.81	.688 171.56	.375 94.71	.969 238.33	1.219 296.63	.500 125.61	1.531 367.64	1.812 429.99	2.062 483.57	2.344 542.44	
26	26.00		.312 85.68	.500 136.30			.375 102.72			.500 136.30					
28	28.00		.312 92.35	.500 146.99	.625 182.90		.375 110.74			.500 146.99					
30	30.00		.312 99.02	.500 157.68	.625 196.26		.375 118.76			.500 157.88					
32	32.00		.312 105.69	.500 168.37	.625 209.62	.688 230.29	.375 126.75			.500 168.37					
34	34.00		.344 123.77	.500 179.06	.625 22.99	.688 245.0	.375 134.79			.500 179.06					
36	36.00		.312 19.03	.500 189.75	.625 236.50	.750 282.62	.375 142.81			.500 189.75					
42	42.00						.375 166.86			.500 221.82					
48	48.00						.375 190.92			.500 253.89					
TOP NUMBER = WALL THICKNESS												BOTTOM NUMBER = WEIGHT PER FOOT			

K05 Light Weight Flexible Coupling

KLAMPz[®] Grooved Piping System

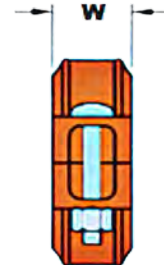
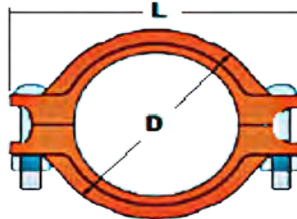

Part Number	Nominal Size	Pipe O.D.	UL/FM Working Pressure	Non-UL/FM Working Pressure	Dimensions (in)			Bolt/Nut Size
					D	L	W	
K050150PE(-ULFM)	1.5	1.900	300 psi	500 psi	2.72	4.49	1.77	0.375" x 1.5"
K050200PE(-ULFM)	2	2.375			3.29	4.88	1.81	0.375" X 2.125"
K050250PE(-ULFM)	2.5	2.875			3.74	5.51	1.81	0.375" X 2.125"
K050300PE(-ULFM)	3	3.500			4.49	6.14	1.81	0.375" X 2.125"
K050400PE(-ULFM)	4	4.500			5.59	7.44	1.97	0.5" X 2.5"
K050500PE(-ULFM)	5	5.563			6.69	8.74	1.97	0.5" X 2.5"
K050600PE(-ULFM)	6	6.625			7.72	9.61	1.97	0.5" X 2.5"
K050800PE(-ULFM)	8	8.625			9.92	12.44	2.36	0.625" X 3.125"
K051000PE(-ULFM)	10	10.750			12.56	15.47	2.52	0.75" X 3.5"
K051200PE(-ULFM)	12	12.750			14.72	17.83	2.56	0.75" X 4.25"
K051400PE(-ULFM)	14	14.000			18.09	20.08	2.95	0.875" x 4.375"
K051600PE	16	16.000			18.19	21.93	3.01	0.875" x 5.5"

AVAILABLE IN:

- UL/FM APPROVED
- NON-UL/FM VERSION

ALL DIMENSIONS ARE IN INCHES UNLESS OTHERWISE STATED.

- 1) Flexible Couplings in straight runs should be supported as close to the coupling as possible, or within the distance.
- 2) Flexible couplings provide either axial or longitudinal movement. The available movement for roll-grooved joints is 1/2 of cut-groove dimensions per ANSI/AWWA C606-06.
- 3) When pre-setting power nut-drivers, the following torque should not be exceeded. Excessive tightening of the nuts could result in joint failure. (Values Lbs-Ft.) 0.375"= 50-59 ; 0.5"=81-92 ; 0.625"= 147-190; 0.75"=177-179; 0.875"=202-221.
- 4) The standard finish is Epoxy Powder Coat, but other finishes are available upon request, including Paint, Dacromet and Hot-Dip Galvanized.
- 5) Compatible with KLAMPz KGE product line.

K10 90° Elbow

K11 45° Elbow

KLAMP^z
Grooved Piping System

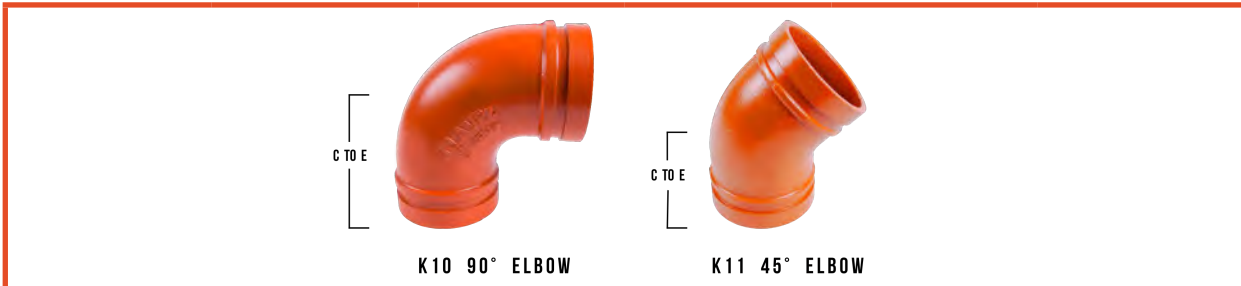

Nominal Size	Pipe O.D.	UL/FM Working Pressure	Non-UL/FM Working Pressure	"C to E" Dimensions	
				K10	K11
1.5	1.900	300 psi	500 psi	2.75	1.75
2	2.375			3.25	2.00
2.5	2.875			3.75	2.25
3	3.500			4.25	2.50
4	4.500			5.00	3.00
5	5.563			5.50	3.25
6	6.625			6.50	3.50
8	8.625			7.75	4.25
10	10.750			9.00	4.75
12	12.750			10.00	5.25

PART NUMBER STRUCTURE

AVAILABLE IN:

- **UL/FM APPROVED**
- **NON-UL/FM VERSION**

Part Number Section	Options
Model	K10, K11
Size	xxxx (4-digits) / (Example: Size=1.25 = 0125)
UL/FM Certification	-ULFM
Example	K100400-ULFM / K110125

ALL DIMENSIONS ARE IN INCHES UNLESS OTHERWISE STATED.

- 1) Fittings are cast ductile iron conforming to ASTM A536, Gr. 65-45-12 Ductile Iron
- 2) Dimensions meet ANSI/AWWA C606-06.
- 3) Center to End Dimensions are manufacture's standard.
- 4) Fittings larger than 14" may be fabricated from steel pipe to ASTM A53, Gr. B or equivalent.
- 5) The standard finish is Epoxy Powder Coat, but other finishes are available upon request, including Paint, Dacromet and Hot-Dip Galvanized.

K20 Tee

KLAMPz[®] Grooved Piping System



Part Number	Nominal Size	Pipe O.D.	UL/FM Working Pressure	Non-UL/FM Working Pressure	C to E
K200150P(-ULFM)	1.5	1.900	300 psi	500 psi	2.75
K200200P(-ULFM)	2	2.375			3.25
K200250P(-ULFM)	2.5	2.875			3.75
K200300P(-ULFM)	3	3.500			4.25
K200400P(-ULFM)	4	4.500			5.00
K200500P(-ULFM)	5	5.563			5.50
K200600P(-ULFM)	6	6.625			6.50
K200800P(-ULFM)	8	8.625			7.75
K201000P(-ULFM)	10	10.750			9.00
K201200P(-ULFM)	12	12.750			10.00

AVAILABLE IN:

- UL/FM APPROVED
- NON-UL/FM VERSION

ALL DIMENSIONS ARE IN INCHES UNLESS OTHERWISE STATED.

- 1) Fittings are cast ductile iron conforming to ASTM A536, Gr. 65-45-12 Ductile Iron.
- 2) Dimensions adhere to ANSI/AWWA C606-06.
- 3) Center to End Dimensions are manufacture's standard.
- 4) Fittings larger than 14" may be fabricated from steel pipe A,STM A53, Gr. B or equivalent.
- 5) The standard finish is Epoxy Powder Coat, but other finishes are available upon request, including Paint, Dacromet and Hot-Dip Galvanized.

K41 Flange Adapter

KLAMPz
Grooved Piping System

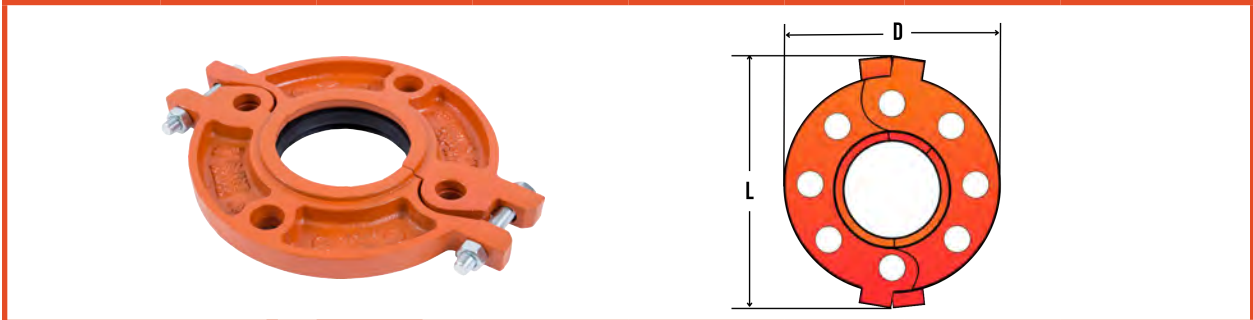

Part Number	Nominal Size	Pipe O.D.	UL/FM Working Pressure	Non-UL/FM Working Pressure	Dimensions (Inches)		# B.H.	Bolt/Nut Size
					D	L		
K410200PE(-ULFM)	2	2.375	250 psi	250 psi	6.46	8.27	4	0.375" x 2.750"
K410250PE(-ULFM)	2.5	2.875			6.93	9.45	4	0.375" x 2.750"
K410300PE(-ULFM)	3	3.500			7.56	9.84	4	0.375" x 2.750"
K410400PE(-ULFM)	4	4.500			8.82	10.94	8	0.375" x 2.750"
K410500PE(-ULFM)	5	5.563			10.00	12.20	8	0.375" x 2.750"
K410600PE(-ULFM)	6	6.625			11.10	13.23	8	0.500" x 3.125"
K410800PE(-ULFM)	8	8.625			13.50	15.55	8	0.500" x 3.125"
K411000PE(-ULFM)	10	10.750			15.91	18.50	12	0.625" x 3.875"
K411200PE(-ULFM)	12	12.750			19.20	23.00	12	0.625" x 3.875"

AVAILABLE IN:

- UL/FM APPROVED
- NON-UL/FM VERSION

ALL DIMENSIONS ARE IN INCHES UNLESS OTHERWISE STATED.

- 1) A hard metal washer is required between the # K41 gasket and any rubber mating surface, i.e. wafer and lug butterfly valves, flexible connectors, etc.
- 2) Two factory supplied closure bolts are included with the Model K41 Grooved Flange Adapter.
- 3) The Model K41 Grooved Flange Adapters should not be used as an anchor point for tie-rods on un-restrained joints
- 4) When mounting the Model K41 Grooved Flange Adapter to valves, assure that there is adequate clearance between the flange and valve handle, operator, etc.
- 5) The standard finish is Epoxy Powder Coat, but other finishes are available upon request, including Paint, Dacromet and Hot-Dip Galvanized.
- 6) Compatible with KLAMPz KGE product line.
- 7) Flange drilling pattern meets ANSI 125/150#

K58 Groove x Bevel Adapter Nipple

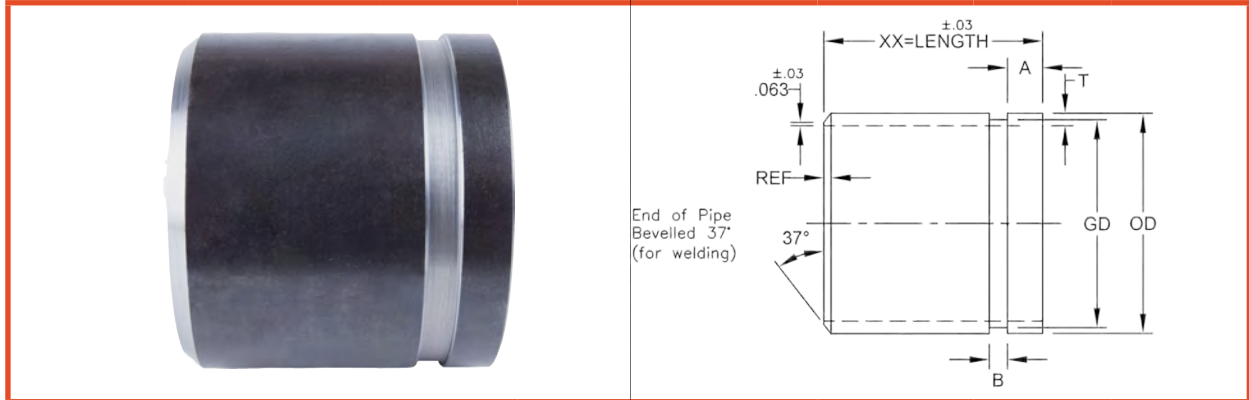

Nominal Pipe Size	O.D.	Wall Thickness	Groove Diameter	"A" (+/-0.03)	"B" (+/-0.03)	"E to E" Length
1.5	1.190	0.145	1.775 (-.015)	0.625	0.313	4
2	2.375	0.154	2.250 (-.015)	0.625	0.313	4
2.5	2.875	0.203	2.720 (-.018)	0.625	0.313	4
3	3.500	0.216	3.344 (-.018)	0.625	0.313	4
4	4.500	0.237	4.334 (-.020)	0.625	0.375	4
5	5.563	0.258	5.395 (-.020)	0.625	0.375	4
6	6.625	0.280	6.455 (-.022)	0.625	0.375	4
8	8.625	0.322	8.441 (-.025)	0.750	0.438	4
10	10.750	0.365	10.562 (-.027)	0.750	0.500	4
12	12.750	0.375	12.531 (-.030)	0.750	0.500	4
14	14.000	0.375	13.781 (-.030)	0.938	0.500	4

ALL DIMENSIONS ARE IN INCHES UNLESS OTHERWISE STATED.

- 1) Pipe nipples are cut-grooved per ANSI /AWWA C606-06.
- 2) Pressure ratings are dependent upon coupling selected.
- 3) Schedule 40 sand blased ASTM A538 black pipe is standard, but different schedules and materials are available upon request.

K60 Grooved Cap

KLAMPz
Grooved Piping System



Part Number	Nominal Size	Pipe O.D	"L"	UL/FM Working Pressure	Non-UL/FM Working Pressure
K600150P(-ULFM)	1.5	1.900	0.94	300 psi	500 psi
K600200P(-ULFM)	2	2.375	0.94		
K600250P(-ULFM)	2.5	2.875	0.94		
K600300P(-ULFM)	3	3.500	0.94		
K600400P(-ULFM)	4	4.500	1.00		
K600500P(-ULFM)	5	5.563	1.00		
K600600P(-ULFM)	6	6.625	1.00		
K600800P(-ULFM)	8	8.625	1.26		
K601000P(-ULFM)	10	10.750	1.26		
K601200P(-ULFM)	12	12.750	1.26		

AVAILABLE IN:

- **UL/FM APPROVED**
- **NON-UL/FM VERSION**

ALL DIMENSIONS ARE IN INCHES UNLESS OTHERWISE STATED.

- 1) Model K60 are cast ductile iron conforming to ASTM A536, Gr. 65.45.12.
- 2) Dimensions adhere to ANSI/AWWA C606-06.
- 3) The standard finish is Epoxy Powder Coat, but other finishes are available upon request, including Paint, Dacromet and Hot-Dip Galvanized.

KGE EPDM Gaskets

KLAMPz[®]
Grooved Piping System



Nominal Size	Pipe O.D
1.5	1.900
2	2.375
2.5	2.875
3	3.500
4	4.500
5	5.563
6	6.625
8	8.625
10	10.750
12	12.750
14	14.000
16	16.000



PART NUMBER STRUCTURE

Part Number Section	Options
Type	KGE
Size	xxxx (4-digits) / (Example: Size=1.25 = 0125)
Model	K05 & K07 = BLANK K41 = -K41
Example	KGE0400-41 (K41) / KGE0125 (K05 & K07)

ALL DIMENSIONS ARE IN INCHES UNLESS OTHERWISE STATED.

- 1) EPDM: TEMPERATURE RANGE (-34°C) -30°F (+110°C) +230°F.
Suitable for water, non-oil, dilute acids, alkaline salt and many non-hydrocarbon chemicals. **DO NOT USE FOR HYDROCARBON SERVICES.**
- 2) Always lubricate gaskets with inert soap-based lube to avoid pinching during installation.
- 3) KGE Series Gaskets are made for KLAMPz K05, K07, and K41 product lines.

KTB Track Head Bolts

KLAMP[®]
Grooved Piping System



ALL DIMENSIONS ARE IN INCHES UNLESS OTHERWISE STATED.

- 1) Bolts are mild steel, heat treated & Zinc electroplated conforming to ASTM A183, Gr.2.
- 2) Hex Nuts conform to ASTM A563 Br. B.
- 3) Threads adhere to UNC (Unified National Coarse) as put forth by ASME/ANSI.
- 4) Tensile strength = 110,000 psi; Yield = 80,000 psi; Elongation = 12%.

WARRANTY**KLAMPz[®]****Grooved Piping System**

We warrant all KLAMPz products to be free from defects in materials and workmanship under normal conditions of use and service. Our obligation under this warranty is limited to repairing or replacing at our option at our factory or designated facility any product which shall within **one year** after delivery to the original buyer be returned with transportation charges prepaid, and which our examination and inspection shall show to our satisfaction to have been defective.

This warranty is made expressly in lieu of any other warranties, express or implied, including any implied warranty of merchantability or fitness for particular purpose. The buyer's sole and exclusive remedy shall be for the replacement or repair of defective products as provided herein. The buyer agrees that no other remedy (including but not limited to, incidental or consequential damages for lost profits, lost sales, injury to person or property or any other incidental or consequential loss) shall be available to him/her.

KLAMPz neither assumes nor authorizes any person to assume for it any other liability in connection with the sale of such products.

This warranty shall not apply to any product which has been the subject to misuse, negligence or accident, which has been repaired or altered in any manner outside of KLAMPz factory or designated facility or which has been used in manner contrary to KLAMPz instructions, recommendations or generally accepted practices. KLAMPz shall not be responsible for design errors due to inaccurate or incomplete information supplied by the buyer or his representatives.



2 YEAR
Warranty

THIS PAGE IS INTENTIONALLY LEFT BLANK

Machining Services

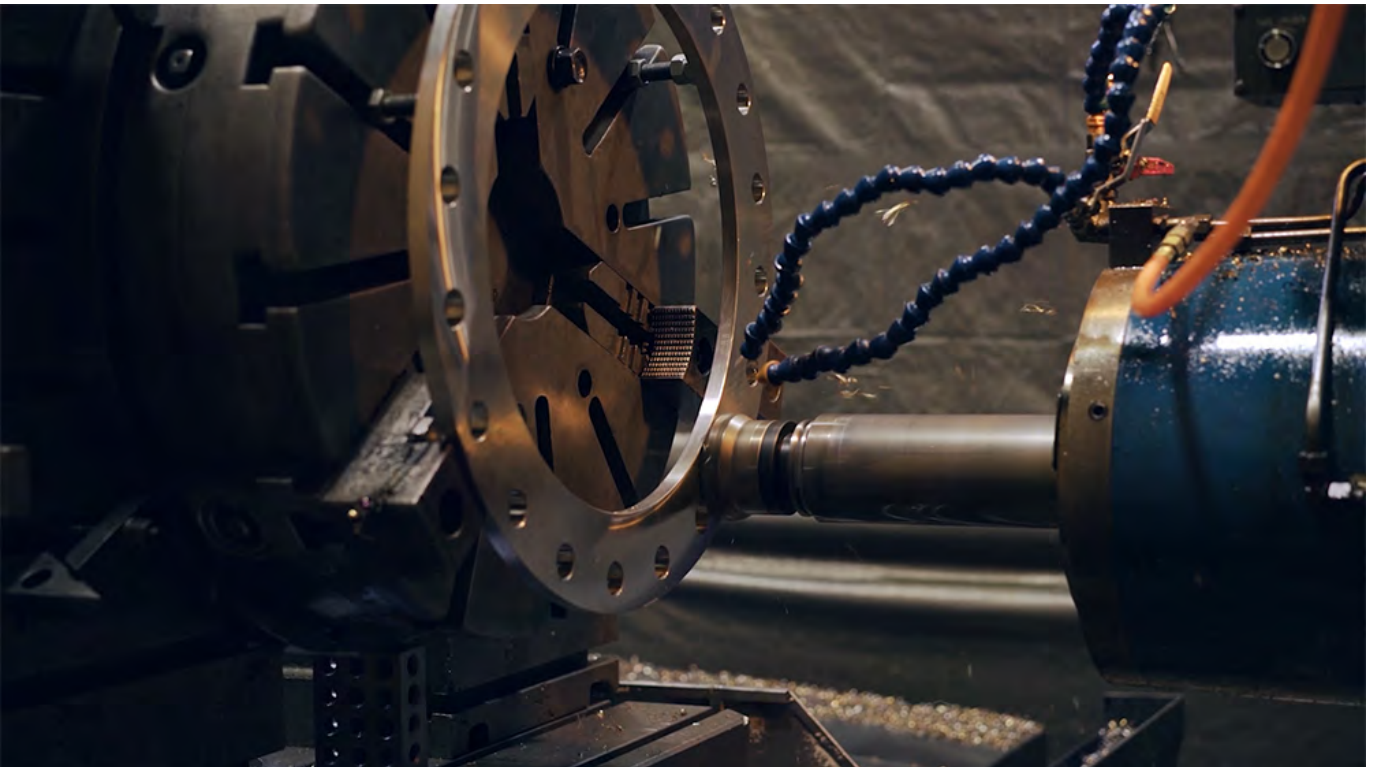
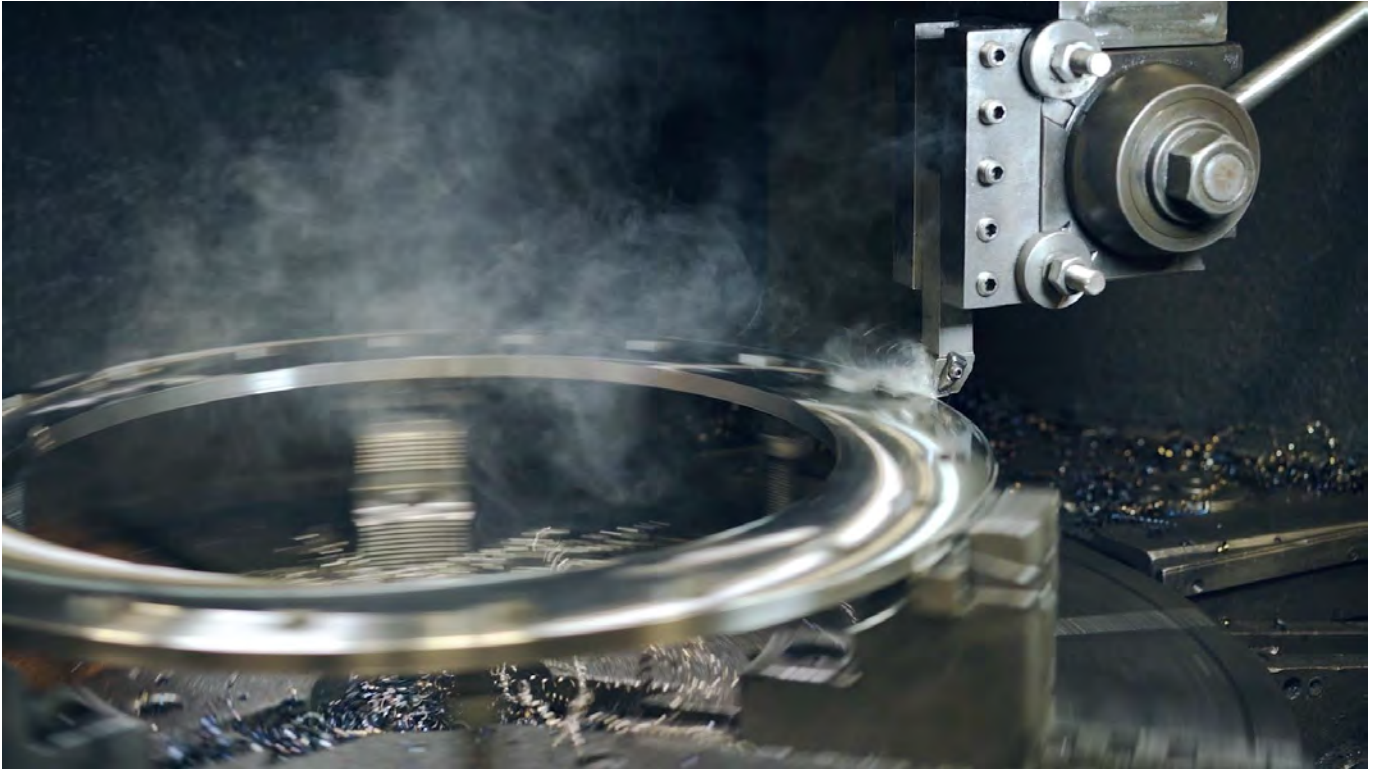

Machining Services - Features & Capabilities

Our machine shop enables API to manufacture product that meets a wide variety of specifications utilizing Buy America, AIS or Import materials. We also support fast turn modifications to our stock items in order to meet customer needs. Whether you have a CAD drawing or sample that needs to be reverse engineered, we can work with you on prototyping, production quantity manufacturing and even warehousing product.

MILLING

- Variety of 3-axis vertical mills allows efficient machining of your part
- Open work envelope of 4-axis horizontal Boring Mill allows machining of parts up to 59"(X) x 39"(Y) x 29"(Z) in size, with the ability to work with larger parts by repositioning

TURNING

- Versatile array of lathes can handle your small to medium size parts Two
- CNC lathes with the ability to turn parts with diameters from 3" to 43" Selection of manual lathes supports
- a turning range of 3" to 108" (118" when ID >= 24")

MATERIAL

- Carbon & Mild Steel
- Stainless Steel
- Aluminum
- Duplex
- Super Duplex
- Alloy 20

*Tooling can be added quickly in order to work with almost any material.

TOLERANCES

Part Size (max)	Tolerance
21"	±.001
42"	±.010
60"	± 1/32
118"	± 1/16

OUR ADVANTAGE

Range of Capabilities:

Experience with a wide variety of products, sizes, materials and specifications.

Quality Control:

Quality control technicians working with modern technology, including a Romer Arm CMM, that verifies all products meet customer requirements.

Quick Turnaround:

Short lead times that allow you to get products to customers when they need them.

Cost Reduction:

Our machine shop's vast knowledge of tooling and fixturing can help reduce your production cost, especially on your high volume products.

Machining Services - Machines

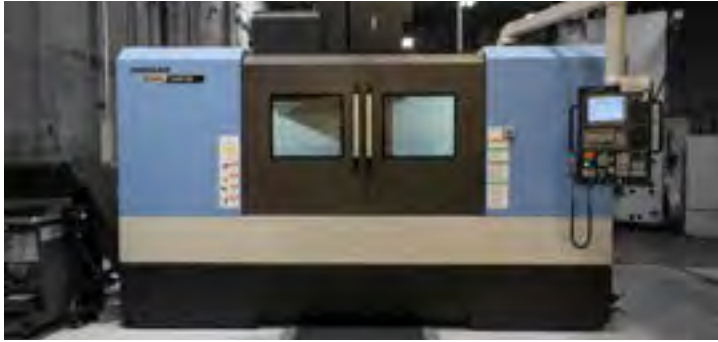

DOOSAN MYNX 7500/50
- CNC MILL

63" x 30" work envelope
Ideal for: Larger parts and exotic materials



DOOSAN DNM 5700
- CNC MILL

40" x 20" work envelope
Ideal for: High speed milling of material such as aluminum and plastic



HYUNDAI WIA LV1100R
- VERTICAL CNC LATHE

Maximum turning diameter: 39"
Ideal for: High volume turning of complex parts up to 39" diameters



DOOSAN DNM 5400/50
- CNC MILL

40" x 20" work envelope
Ideal for: Precision drilling & milling



BULLARD DYNATROL
- VERTICAL TURRET LATHE

Maximum turning diameter: 108"
Ideal for: Turning rings and flanges with 42" to 108" outer diameters

Machining Services - Machines



**MONARCH 96" VMC-RT
- CNC DRILLING MACHINE**

Drill holes 0.25" - 3" diameter
Work piece: 20" - 108" diameter
Ideal for: Drilling bolt holes



**QUICKDRILL GANTRY MACHINING CENTER
- HORIZONTAL CNC MILL**

120" x 120" work envelope
Ideal for: Drilling and milling large
8" thick flanges up to 18ft in
diameter



**IKEGAI NB11T
- HORIZONTAL CNC MILL**

Horizontal milling with 59" x 39"
work envelope
Ideal for: Multi-axis milling and
boring



**DOOSAN PUMA 480
- HORIZONTAL CNC LATHE**

Maximum turning diameter: 21.5"
Maximum length of work: 39"
Ideal for: High volume turning of
complex parts



**SENFENG SF1500HC
- FIBER LASER**

Ideal for: Rust removal, paint removal,
grease removal, weld cleaning



**FRYER VT-80
- VERTICAL TURRET LATHE**

Max Cutting Length 32"
Cutting Diameter Range 4" - 80"
Ideal for: High volume turning of complex
parts up to 80" diameter

Butterfly Valves Installation, Operation, & Maintenance Guide

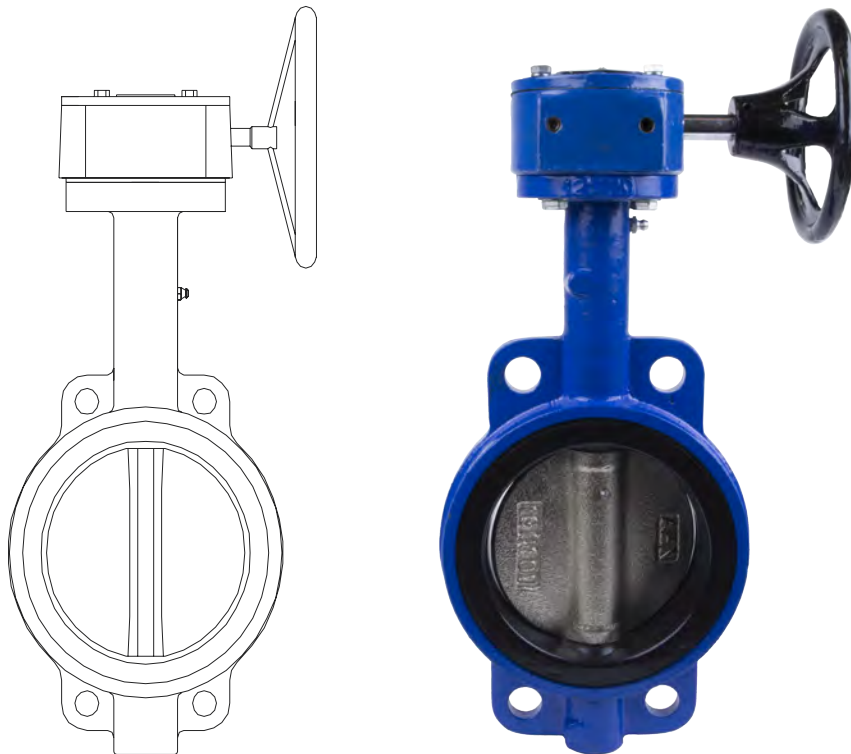

Installation, Operation, & Maintenance - BV/BV-D Butterfly Valves

PREFACE

The following information should be followed in addition to the requirements set forth by an on-site, process engineer or professional pipe fitter. API recommends that only experienced, skilled personnel be allowed to install and maintain the API “BV” style butterfly valves and valve extensions.

GENERAL INFORMATION

API “BV” butterfly valves are designed for installation between ANSI Class 125/150 flat or raised face flanges to regulate flow in a pipeline. Gaskets are not required. Lined pipe, heavy wall pipe, or flanges must have a minimum allowable inside diameter at the center body face to clear the disc sealing edge when opening the valve.

The disc, positioned in the center of the pipe, rotates so that the valve can be opened, closed, or partially opened (with 10 total locking position options).

Prior to selection, double-check the performance limits of the butterfly valves against the anticipated operating conditions including the following:

1. Material compatibility of the seat, disk, and body with the media.
2. Maximum start-up, test, and working pressure.
3. Maximum temperature.
4. Other operating conditions/media - including flow rates, viscosity... etc.
5. Space requirements for correct installation.

Butterfly valves should not be subjected to operating conditions beyond the capacity for the service recommendations of API International.

UNPACKING & INSPECTION

Upon receipt of API “BV” butterfly valve product, we recommend the following unpacking & inspection procedures:

All valves are packaged and shipped in a manner designed to prevent damage during transportation. If obvious external damage to the shipping container or package is evident upon receipt of the product, please request a representative of the shipping carrier be present prior to unpacking the product.

Remove all packing materials surrounding the valve and carefully lift it from the container. Caution, for large or heavy valves, the appropriate material for handling equipment must be used to prevent injury and/or possible damage to the valve. API recommends keeping the shipping container and all packing material for reuse in storage or reshipment.

Visually inspect valves for any signs of damage including scratches, loose parts, broken parts, or any other physical damage that may have occurred during shipment. If damage is observed, immediately file a claim with the shipping carrier. Butterfly valves that are damaged during transportation are the responsibility of the customer.

Installation, Operation, & Maintenance - BV/BV-D Butterfly Valves

UNPACKING & INSPECTION (Continued)

Inspect further to confirm that there are no pieces of packaging left on the valve that could interfere with its operation.

If valves are not going to be installed immediately, they should be stored indoors in a clean, dry, corrosion-free environment without direct exposure to sunlight. The discs should remain in the nearly closed position to protect the sealing edge and to prevent distortion of the resilient seat. No other maintenance during storage or use is required.

INSTALLATION

Pre-Installation Information/Checklist:

1. Ensure working conditions (pressure and temperature) are within the specified capacity of the product being installed.
2. Make sure that the construction material of the butterfly valve is chemically compatible with the media flowing in the pipeline.
3. Inspect the valve's flange ends and the pipeline's mating flanges to ensure the surfaces are clean and free of defects. The pipeline should also be checked for proper alignment. API butterfly valves should never be utilized to realign an existing piping system.
4. The distance between pipe flanges should be checked to assure sufficient clearance for valve installation.
5. The appropriate material handling equipment should be available to lift larger valves into position.
6. API butterfly valves are bi-directional and may be installed with flow in either direction, vertically, or horizontally. If a choice of stem position exists, the valve should be installed with the stem in the horizontal position; this will minimize seat wear by distributing the stem and disc weight evenly. Also, if the media is abrasive, the horizontal stem position creates a self-flushing effect that will extend the service life-expectancy of the valve.
7. Check that the existing pipe sizes match the inlet and outlet sizes of the unit being installed and that no interference exists. If pipeline strain is a concern with larger valves (due to weight), additional support may be necessary.
8. Since the rubber seat also functions as the seal between the flanges, additional gaskets are not required.
9. If possible, butterfly valves are recommended to be installed a minimum of six (6) pipe diameters from upstream components, and a minimum of four (4) pipe diameters from downstream components.

Installation Procedure:

1. Install lever (for manual operated valve) or hand-wheel (for gear operated valve).
2. Using lever or hand-wheel, turn (clockwise) to ensure valve is in full closed position. Disc should be aligned parallel to the ends.
3. If disc is not aligned parallel to the ends, for lever style - slightly loosen top plate (by loosening 2 bolts), turn lever clockwise until disc is centered & parallel to ends, and retighten top plate. For gear operated valve, adjust hex nuts on side of gearbox. Fully open and close disc several times to assure proper operation. If re-alignment is necessary, repeat.
4. Proceed with valve installation into piping system. Note that "wafer" style valves are placed between flanges and installed with fully threaded studs, whereas tapped "lug" style valves are installed between flanges with small cap screws on the inlet and the outlet of the valve.
5. Spread the mating flanges to exceed the valve's face-to-face dimension by 3/16" before placing the valve into position to prevent distortion and/or damage to the sealing face of the seat.

Installation, Operation, & Maintenance - BV/BV-D Butterfly Valves

Installation Procedure (continued):

6. Ensure that the pipe flange faces are clean of any foreign material such as scale, metal shavings or welding slag.

7. With disc in the closed position, carefully insert between the flanges, line up, and center. Note that accurate centering between upstream and downstream pipe ends is essential for trouble-free operation of the valves.

8. While gradually removing the flange spreader and verifying that the valve is centered to the flanges, secure by hand-tightening flange bolts.

9. Open the valve slowly to the full open position to assure free unobstructed disc movement and that there is no contact with the piping or mating flanges. Note that disc interference may result when valves are installed in pipelines having smaller than normal inside diameters, such as heavy wall pipe, plastic-lined pipe, as-cast flanges or reducing flanges. Interference can also occur when connecting directly to a swing check or silent check. Suitable corrective measures must be taken to remove these obstructions, such as taper boring the pipe, or installing a spacer or spool piece.

10. After proper operation is verified, flange bolts should then be tightened, using a star or crisscross pattern to evenly load the bolts, to the torque values shown below in table 1.

11. Pressurize piping to valve and inspect for leakage. If leakage is observed, tighten bolts using cross-over pattern, increasing torque until leak stops. Note that recommended torques are made without warranty. Installer must verify proper strength bolts for applications. Bolts should be clean and un-lubricated.

Table 1 Recommended bolt torque

Size	Ft-Lbs.
2" - 4"	36
5" - 8"	65
10" - 12"	87
14" - 16"	200
18" - 20"	270

Installation, Operation, & Maintenance - BV/BV-D Butterfly Valves

Installation/General Cautions:

1. Class 250 cast iron and Class 300 steel flanges can not be used on these valves.
2. Rubber faced or mechanical flanges are not recommended.
3. BV/BV-D valves are not recommended for steam service.
4. To avoid damage to the seat from heat, valves should not be assembled to flanges when welding flanges into the piping system.
5. Valves should not be installed in areas where inspection is not possible.
6. Lever style valves are available up to 12", but depending on flow velocity and other factors, 8" and larger valves may require gear operator to fully close.
7. Ensure to fully open valves before a loop test of the piping system is carried out with line pressure of tested valves.
8. When valves need to be dismantled from pipes for maintenance or any other cause, ensure to thoroughly relieve the line pressure beforehand. Loosening piping bolts under line pressure is dangerous and can cause damage to the valve. Any residual fluid left inside the pipeline must be completely drained.

MAINTENANCE

API BV/BV-D butterfly valves require only minimal regular maintenance. The following represents a preventive checklist:

1. Check (and adjust if necessary) that the valve is operating properly in the full closed and full open position.
2. Visually inspect the valve and around the valve for any signs of leakage.
3. Visually inspect bolts, piping, wiring, and any other related equipment for problems that could hinder operation (such as loosening or corrosion).

OTHER NOTES

API BV/BV-D valves come equipped with grease/zerk fittings for easy injection of grease. For severe applications (where valve may be completely submerged), to prevent internal rusting, grease should be fully injected as follows:

1. Valve Body - Grease fitting is located on the neck of the valve. As received, the body does not contain grease. For severe applications, slowly apply grease through fitting until excess can be seen between the shaft and Teflon seat. If Teflon bushing begins to "blow" out, relieve excess pressure by removing grease fitting. Once pressure is relieved, push Teflon bushing back into valve, and re-install grease fitting.
2. Gear Operator - Grease/Zerk fitting is located on the side of the gear box. There is sufficient grease in the gear box for standard applications, however for severe applications, fill with lithium based grease either by removing top plate, or using grease fitting.

Rubber Expansion Joints Installation Guide

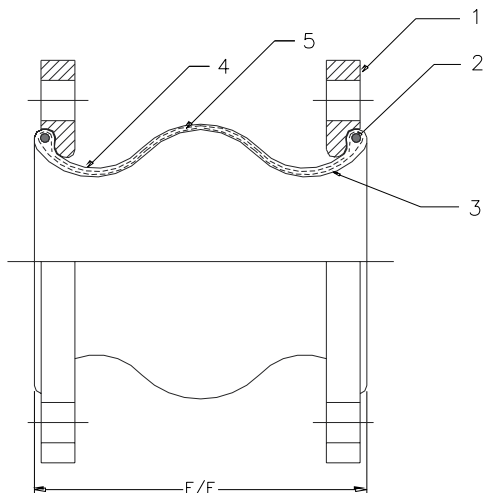

Installation Instructions - Series AMS/AMT Expansion Joints

PREPARATION

- 1. Check Application Criteria.** Double-check the performance limits of the expansion joint against the anticipated operating conditions. Expansion joints should never be subjected to operating conditions beyond the temperature, pressure, and/or vacuum service recommendations of API International. If the total motions due to initial installation and the movements of pipelines during system operation exceed the published maximum allowable movement, then the pipeline should be altered to reduce the initial installation movements. Also, the line should be anchored to EJMA (Expansion Joint Manufacturers Association) specifications to limit the pipe movements that the expansion joint must absorb. For elevated temperatures (above 110° F), contact API Sales for maximum operating pressures.
- 2. Check Location.** Generally, the proper location of rubber expansion joints is installed close to a main anchor point. Following the joint in the line, a pipe guide, or series of guides, should be installed to keep the pipe aligned and prevent undue displacement (of the pipe). This is the simplest application of a joint, namely, to absorb the expansion and contraction of a pipeline between fixed anchor points.
- 3. Check Expansion Joint.** Check the interior, exterior, and flange faces for damage or cracks prior to placing into service. The cover is designed to keep harmful material from penetrating the carcass of the joint.
- 4. Check Alignment.** Piping should be lined up within a maximum of +/- (1/8"). If piping offset is greater than 1/8", and can not be corrected, a special offset joint should be designed and used for the application.
- 5. Check Support.** Piping must be supported by hangers or anchors, so that its weight is not carried by the expansion joint.
- 6. Check Flanges.** Be sure that companion flanges to be mated with the flanges of the expansion joint are clean. Used parts should be carefully examined for reasonable smoothness, and any adhering particles of old gasketing or other foreign material should be scraped off, taking care not to gouge or mutilate the flange surface. When attaching beaded end flange expansion joints to raised face flanges, the use of ring gaskets are required to prevent metal flange faces from cutting the rubber bead during installation.

Note: Never install expansion joints next to wafer type check or butterfly valves. Serious damage to the rubber flange bead can result due to the lack of flange mating surface and/or bolt connection.

WARNING: Expansion joints may operate in pipelines or equipment carrying fluids and/or gases at elevated temperatures and pressures and may transport hazardous materials. Precaution should be taken to periodically inspect the joints and protect personnel in the event of leakage or splash. Rubber expansion joints should not be installed in areas where inspection is not possible.

Note: Some of this information has been replicated from the "Fluid Sealing Association Handbook" on Non-Metallic Expansion Joints.

Installation Instructions - Series AMS/AMT

Expansion Joints

INSTALLATION

Apply Lubricant. Rubber expansion joints face flanges may be painted with a solution of graphite in water or glycerin to prevent adherence of joint to pipe flanges. Petroleum lubricants should not be used.

Insert Expansion Joints into Position. Do not use gaskets for AMS/AMT series. Care must be taken when pushing the joint into the breach between the mating flanges so as not to roll the leading edge of the joint out of its flange groove. Do not bolt directly to another component with an elastomeric face or to a specialty flange without inserting a solid full face metallic gasket.

Insert Bolts. Bolts should be inserted from the arch side (so that bolt heads are adjacent to arch) to ensure that bolts do not interfere with arch during periods of compression.

Tighten Bolts. Tighten all bolts gradually and equally by alternating around the flange in a diagonal manner to the recommended torque values listed below. If a water tight seal is not achieved after initial tightening, slightly tighten nuts until leak is sealed. Do not over tighten to the point where there is metal to metal contact between the rotating flange and the pipe flange. Check bolt tightness at least one week after system is started up and periodically thereafter. As any rubber-like material takes a “set” after a period of compression, the bolts may loosen and result in a broken seal. In a hot and cold water system, the bolts should be checked before changing from one medium to another.

RECOMMENDED BOLTING TORQUE (AMS/AMT Series):

Sizes: 1” thru 2” - 45 ft-lb. 2-1/2” thru 8” - 60 ft-lb. 10” thru 20” - 80 ft-lb.

Control Rods. For piping systems that are not anchored, control rods must be used. Control rods are always recommended as a safety precaution (even when system is properly anchored and guided).

Additional Tips.

- Insulation over a non-metallic rubber expansion joint is not recommended; however, if the insulation is required, it should be made removable to permit easy access to the flange area, to check bolting.
- Do not weld in the vicinity of a non-metallic expansion joint.
- If the expansion joint is to be installed outdoors, appropriate outer cover material must be used to withstand the ozone, sunlight...etc.

WARNING: Expansion joints may operate in pipelines or equipment carrying fluids and/or gases at elevated temperatures and pressures and may transport hazardous materials. Precaution should be taken to periodically inspect the joints and protect personnel in the event of leakage or splash. Rubber expansion joints should not be installed in areas where inspection is not possible.

Note: Some of this information has been replicated from the “Fluid Sealing Association Handbook” on Non-Metallic Expansion Joints.



api
INTERNATIONAL